

# Mayland

Design Guidance and Codes Report

**Final report**  
Updated January 2024

## Quality information

Prepared by	Check by	Approved by
Hoorieh Morshedi	Rose Bateman	Ben Castell
Urban Designer	Senior Urban Planner	Director
Chatnam Lee		
Graduate Urban Designer		

## Revision History

Issue no.	Issue date	Details	Issued by	Position
3	12/01/2024	Post-consultation updates	Ben Castell	Director
2	14/11/2022	Review	Ben Castell	Director
	14/11/2022	Research, site visit, drawings	Hoorieh Morshedi	Urban Designer
	14/11/2022	Research, drawings	Chatnam Lee	Graduate Urban Designer
1	19/10/2022	Review	Peter Spires	Chair of Mayland NP Committee
	26/09/2022	Review	Ben Castell	Director
	26/09/2022	Research, site visit, drawings	Hoorieh Morshedi	Urban Designer
	05/08/2022	Research, drawings	Chatnam Lee	Graduate Urban Designer

This document has been prepared by AECOM Limited ("AECOM") in accordance with its contract with Locality (the "Client") and in accordance with generally accepted consultancy principles, the budget for fees and the terms of reference agreed between AECOM and the Client. Any information provided by third parties and referred to herein has not been checked or verified by AECOM, unless otherwise expressly stated in the document. AECOM shall have no liability to any third party that makes use of or relies upon this document.

# Contents

<b>1</b>	<b>1. Introduction</b>	<b>5</b>
	1.1 Aims and objectives	5
	1.2 Process	6
	1.3 Area of study	7
<b>2</b>	<b>2. Policy context</b>	<b>10</b>
<b>3</b>	<b>3. Neighbourhood Area context analysis</b>	<b>15</b>
	3.1 Surrounding context	15
	3.2 Movement network	17
	3.3 Green and blue infrastructure	19
	3.4 Topography and flood risk	21
		23
<b>4</b>	<b>4. Design guidance and codes</b>	<b>25</b>
	4.1 Introduction	25
	4.2 Checklist	76
<b>5</b>	<b>5. Delivery</b>	<b>84</b>

Introduction

# 01



# 1. Introduction

**Through the Department for Levelling Up, Housing and Communities (DLUHC) Programme led by Locality, AECOM was commissioned to provide design support to Mayland Parish Council.**

## 1.1 Aims and objectives

The purpose of this document is to provide an appreciation for the existing character of Mayland Parish in order to create design codes which will apply to any future housing development in the village. This will help to ensure that as any new development comes forward, it responds to its context and supports and enhances the quality of the villages' existing character.



F.1

Figure 01: A view towards Lawling Creek

## 1.2 Process

The following steps were agreed with the Neighbourhood Plan Steering Group to produce this report:

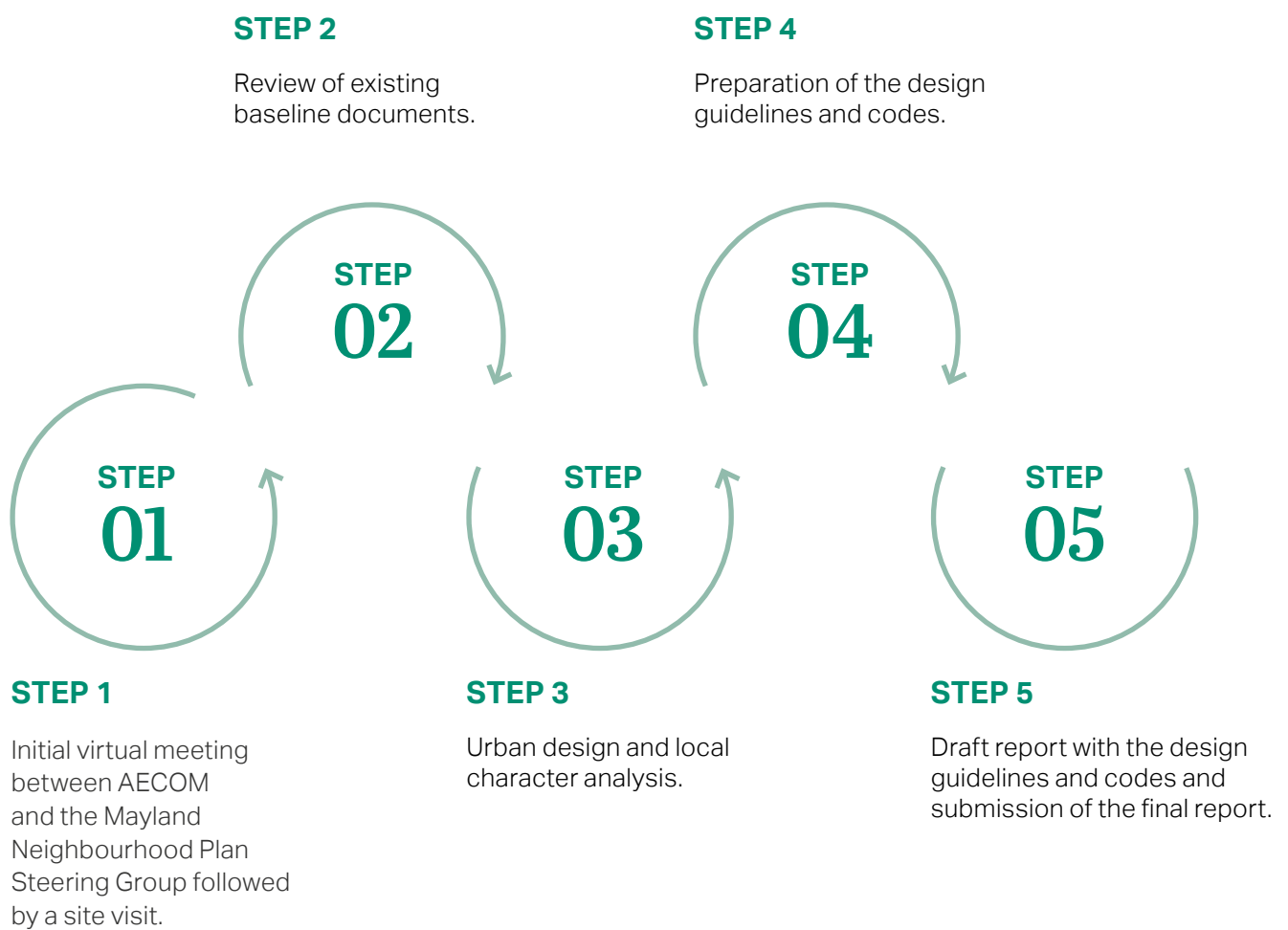

## 1.3 Area of study

Mayland Parish is located in the Maldon District of Essex County, bordering Mundon Creek and an estuary of River Blackwater to the north. It is situated 7.6km north-west of Southminster, and 14km south-east of Maldon. The north of the parish also falls within the Blackwater Estuary Ramsar site, which is also a Site of Special Scientific Interest (SSSI). The village is mostly serviced by local roads and the B1016 which runs east-west along the south of the parish. The closest railway station is outside the parish in Southminster.

The main settlement area of Mayland village is to the north of the parish, with houses fronting onto Lawling Creek alongside the Blackwater Marina and a couple of sailing clubs along the scenic Sea Wall Walk. Mayland village is also home to small independent retailers, several pubs and restaurants as well as Maylandsea Community Primary School. Some of the other facilities in the parish include St Barnabas Church and the Maylandsea GP clinic and Trinity Medical Practice.

There is a small designated employment area at Mayland Industrial Estate which is located close to Mayland Mill and Cardnell's yard on the riverside. Light industries, warehouses and scrap yards are located in these designated areas beyond the settlement area of Mayland.



**Figure 02:** Open space at Blackwater Bistro Pub fronting Blackwater Marina, Maylandsea.

**Figure 03:** Village shops and services.

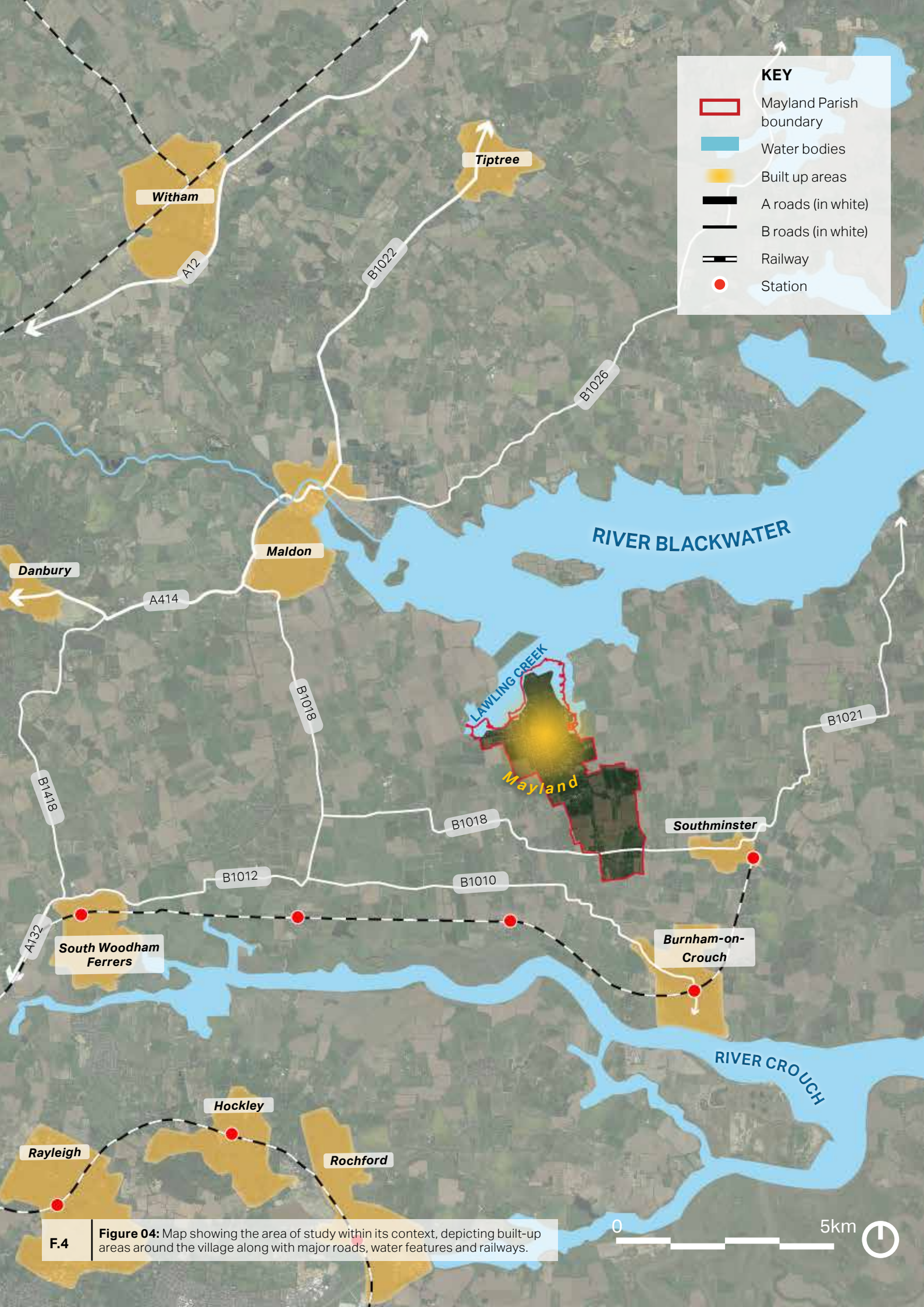

**F.4** **Figure 04:** Map showing the area of study within its context, depicting built-up areas around the village along with major roads, water features and railways.



Policy context

02

## 2. Policy context

### 2.1 Introduction

As the National Planning Policy Framework (NPPF) (paragraph 131) notes, “good design is a key aspect of sustainable development, creates better places in which to live and work and helps make development acceptable to communities”.

Applicants should refer to national and local policy documents when planning future developments in Mayland.

### 2.2 National and local policy and guidance

The following national and local policy documents and best practice guidance have informed the design guidance within this report.

#### 2023 - National Planning Policy Framework

DLUHC

Development needs to consider national level planning policy guidance as set out in the NPPF and the National Planning Policy Guidance (NPPG). In particular, Chapter 12: Achieving well-designed places of the NPPF stresses the creation of high-quality buildings and places as being fundamental to what the planning and development process should achieve. It sets out a number of design principles that planning policies and decisions should consider ensuring that new developments are well-designed and focus on quality.

#### 2021 - National Design Guide

DLUHC

The National Design Guide illustrates how well-designed places that are beautiful, enduring and successful can be achieved in practice.

#### 2021 - National Model Design Code

DLUHC

The National Model Design Code provides guidance on the production of design codes, guides and policies to promote successful and good quality design. It expands on the ten characteristics of good design set out in the National Design Guide and should be referred to in the development of design codes at the local and site masterplan level.

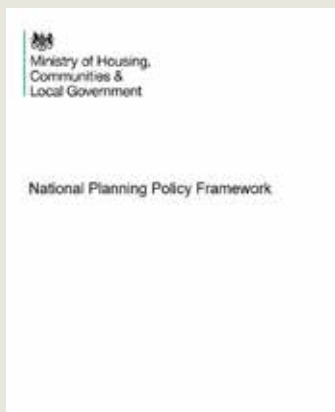

NATIONAL LEVEL

NATIONAL LEVEL

### 2020 - Building for a Healthy Life Homes England

Building for a Healthy Life is the government-endorsed industry standard focused on twelve design considerations for creating a successful built environment that promotes wellbeing.

### 2007 - Manual for Streets Department for Transport

Development is expected to respond positively to the Manual for Streets, the Government's guidance on how to design, construct, adopt and maintain new and existing residential streets. It promotes streets and wider development that avoid car dominated layouts and encourage active travel.

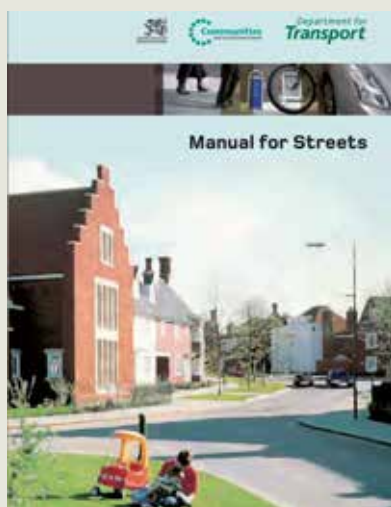

COUNTY AND DISTRICT LEVEL

### 2011 - Maldon District Green Infrastructure Study Maldon District Council

This document assessed local need for open space provisions, taking into account varying socio-demographic and cultural characteristics of the local community, and examines the existing supply of facilities in term of function, level of use, quantity, quality and accessibility. It set out local standards based on the findings from the assessment bearing in mind differences between urban and rural areas in terms of the level of provision. In addition, it identifies green infrastructure networks and recommend how the provision of green infrastructure could be improved to contribute to wider sustainability objectives.

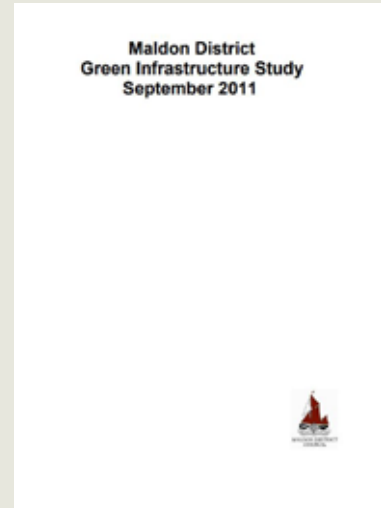

**2018 - Essex Design Guide**

**Essex Local Authorities**

The Essex Design Guide sets out local best practice guidance and design principles for creating high-quality sustainable development in Essex. It responds to the unique design challenges and opportunities in Essex which have informed the development of this design guide.

The Essex Design Guide covers a wide range of design considerations including climate change, active design, ageing population, health and wellbeing, digital and smart technology and garden communities. It also sets out the latest standards for design details of buildings, development layout, parking, street layout, flood management and landscaping in Essex.

**2017 - Maldon District Local Development Plan 2014-2029**

**Maldon District Council**

The adopted Maldon District Local Development Plan sets out the spatial vision for Maldon’s growth up to 2029. It seeks to protect the district’s unique identity by maintaining high design standards and the principles of sustainable design in new development. Mayland is identified as a ‘larger village’ in the adopted Local Plan. Policy D1 Design Quality and Built Environment sets out the key design requirements for all development in Maldon.

Maldon District Council is currently reviewing the Local Development Plan.

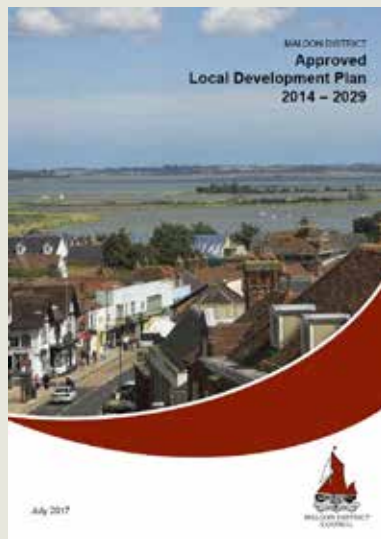
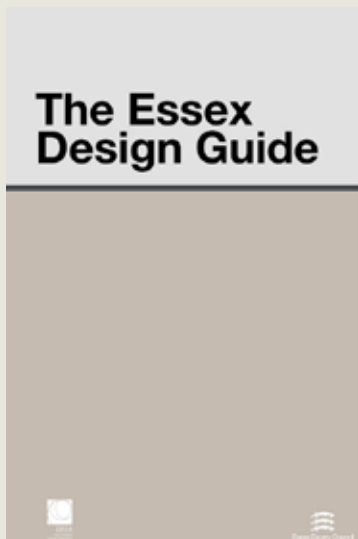

**2017 - Maldon District Design Guide  
Supplementary Planning Document**  
Maldon District Council

The Maldon District Design Guide Supplementary Planning Document (SPD) supports the policies contained in the adopted LDP and provides clear design principles to guide future development in the district. It seeks to encourage a design-led approach to development of all schemes from residential extensions to large residential proposals. This Design Guide takes into account the 21 design principles set out in the adopted SPD.



**2018 - Maldon District Renewable  
and Low Carbon Technologies  
Supplementary Planning Document**  
Maldon District Council

The Renewable and Low Carbon Technologies SPD offers technical guidance to reduce carbon emissions in new developments. It requires development to demonstrate sustainability through design, construction and the use of low carbon technologies. It also sets out design advice in relation to the positioning of low carbon technologies infrastructure (including solar panels and heat pumps), urban cooling and landscaping.

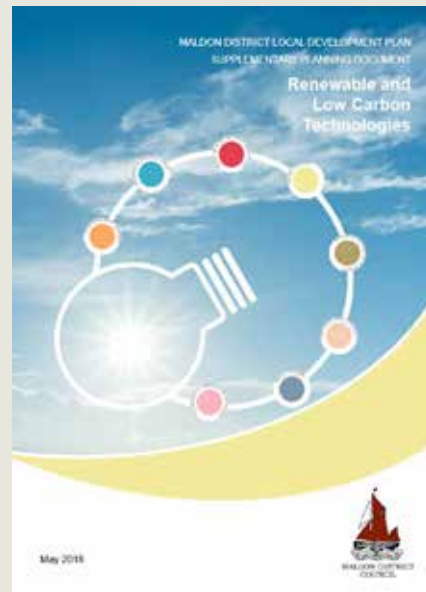

A photograph of a residential street under a clear blue sky. In the foreground, there is a grey asphalt road and a concrete curb. A brick wall with a black metal fence runs across the middle ground. Behind the wall, there are several houses. On the left, a house with a dark roof and light-colored walls. In the center, a house with a green roof and white walls. On the right, a brick house with a red roof. A large teal circle is overlaid on the center of the image, containing white text.

Neighbourhood Area  
context analysis

03

# 3. Neighbourhood Area context analysis

**This chapter describes the local context and key characteristics of Mayland Parish related to the local history, built environment, streetscape and landscape.**

## 3.1 Surrounding context

Mayland is located inland from the River Blackwater. The parish is largely characterised by estuarine mudflats and salt marshes to the north of Maylandsea, and rolling open farmlands that south of the parish towards Althorne and east towards Southminster. The northern part of Mayland falls within the Blackwater Estuary Ramsar site and SSSI.

Mayland originated as a manor back in the 12th century, which formed part of the endowment of St Osyth Priory. The early community of Mayland consisted of scattered farms across the parish. St Barnabas Church was established in 1866 after Mayland manor was acquired by St Bartholomew’s Hospital in the 18th century. Mayland also had a shipbuilding legacy which can be traced back to the 20th century when the Cardnells Boat yard was established. Since then, Mayland has become a major sailing centre in the area and has led to the establishment of various clubhouses.

The built character of Mayland consists of properties with red brick facades, interspersed with off-white rendered facades. The rest of the settlement comprises isolated dwellings and scattered farmstead throughout the rolling farmland

and fields, with field boundaries framed by hedgerows and ditches. Various stretches of deciduous woodlands intersperse the landscape of Mayland Parish and its surrounding area. The village benefits from a network of Public Rights of Way including footpaths and several restricted byways that connect the village to the surrounding open fields and countryside.

The main retail frontages located on Imperial Avenue including the supermarket, post office, restaurants, a pharmacy and other businesses. Sports Ground in Lawling Park is another important facility within the village.

There are three Grade II listed buildings within the parish - the Mayland Mill Public House, Highlands Farmhouse and Barn.



**Figure 05:** Boat yard fronting onto Lawling Creek, Mayland.  
**Figure 06:** George Cardell Memorial Field, Mayland.

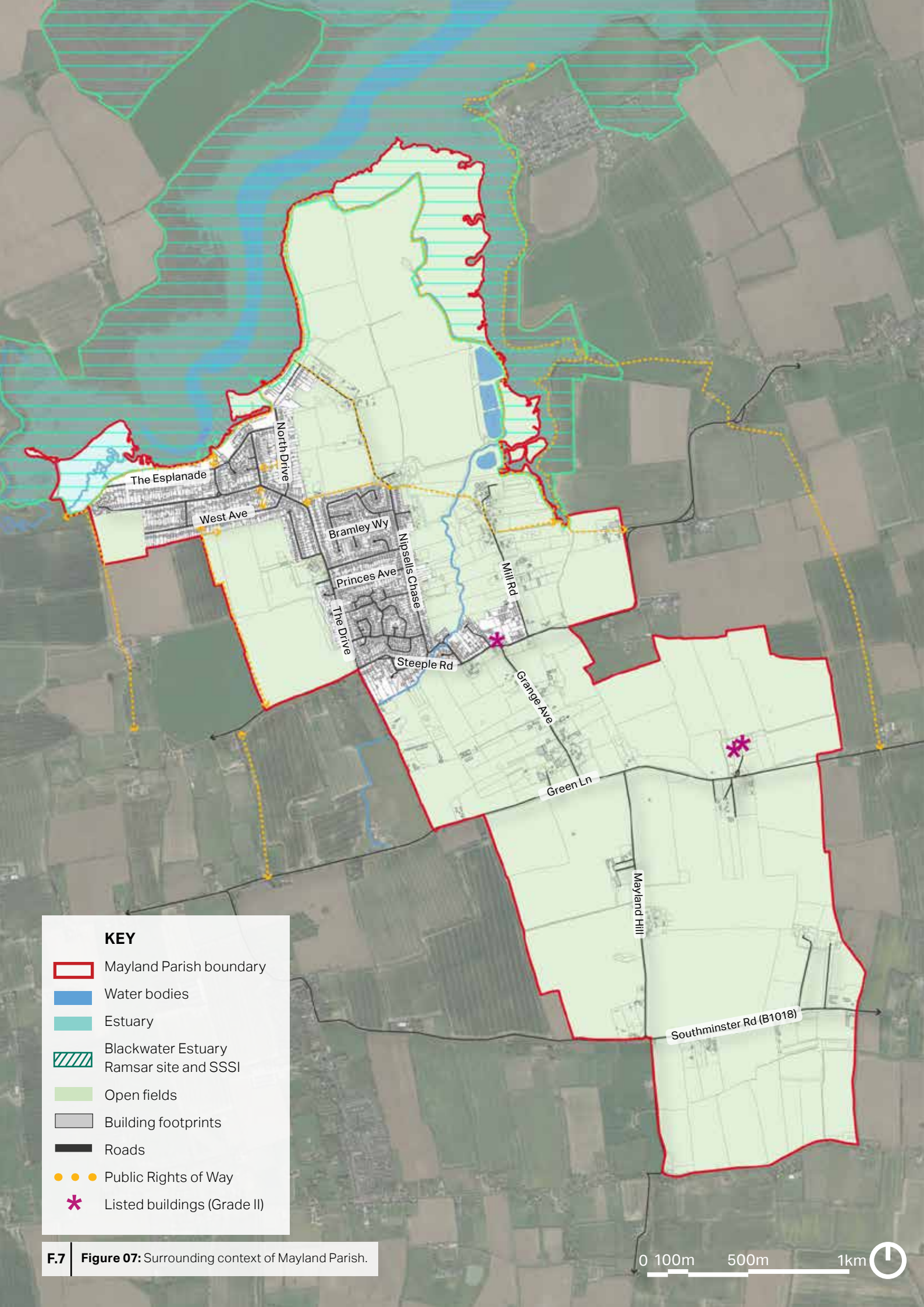

**KEY**

- Mayland Parish boundary
- Water bodies
- Estuary
- Blackwater Estuary Ramsar site and SSSI
- Open fields
- Building footprints
- Roads
- Public Rights of Way
- \* Listed buildings (Grade II)

**F.7** Figure 07: Surrounding context of Mayland Parish.

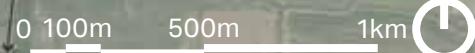

### 3.2 Movement network

The major route of B1018 runs east-west along the south of Mayland Parish. Mayland Hill Road and Grange Avenue are secondary routes that lead off of the B1018 to provide access to the main settlement area of Mayland/Maylandsea towards the north of the parish.

The main settlement is developed along two north-south axes of The Drive on the west and Nipsells Chase on the east in a linear pattern. A series of residential tertiary roads and cul-de-sacs branch out from these roads towards residential clusters in the centre of the village.

The linear pattern of development continues north of the village where rows of houses are arranged parallel to the waterfront along The Esplanade, Imperial Avenue and West Avenue. Steeple Road forms an east-west axis to the south of the village, providing connections towards housing clusters and the Henry Samuel Hall to the east, and scattered farmhouses to the west.

Most of the residential roads in Mayland are equipped with pavements to facilitate a safe and walkable environment to residents, however, many of these can benefit from better maintenance and repair from wear.

There is a network of Public Rights of Way (PRoW) that branch off from tertiary roads and cul-de-sacs that connect the main settlement area with the waterfront and surrounding countryside.

Car parking remains an issue in the village, particularly around shops near Imperial Avenue and the village's exit at Steeple Road, which are heavily blighted by off road parking that results in congestion.



**Figure 08:** The primary route of B1018 (Southminster Road) provide east-west connections across the southern part of the parish.

**Figure 09:** A typical residential street in Mayland with wide pavement on one side of Imperial Avenue.

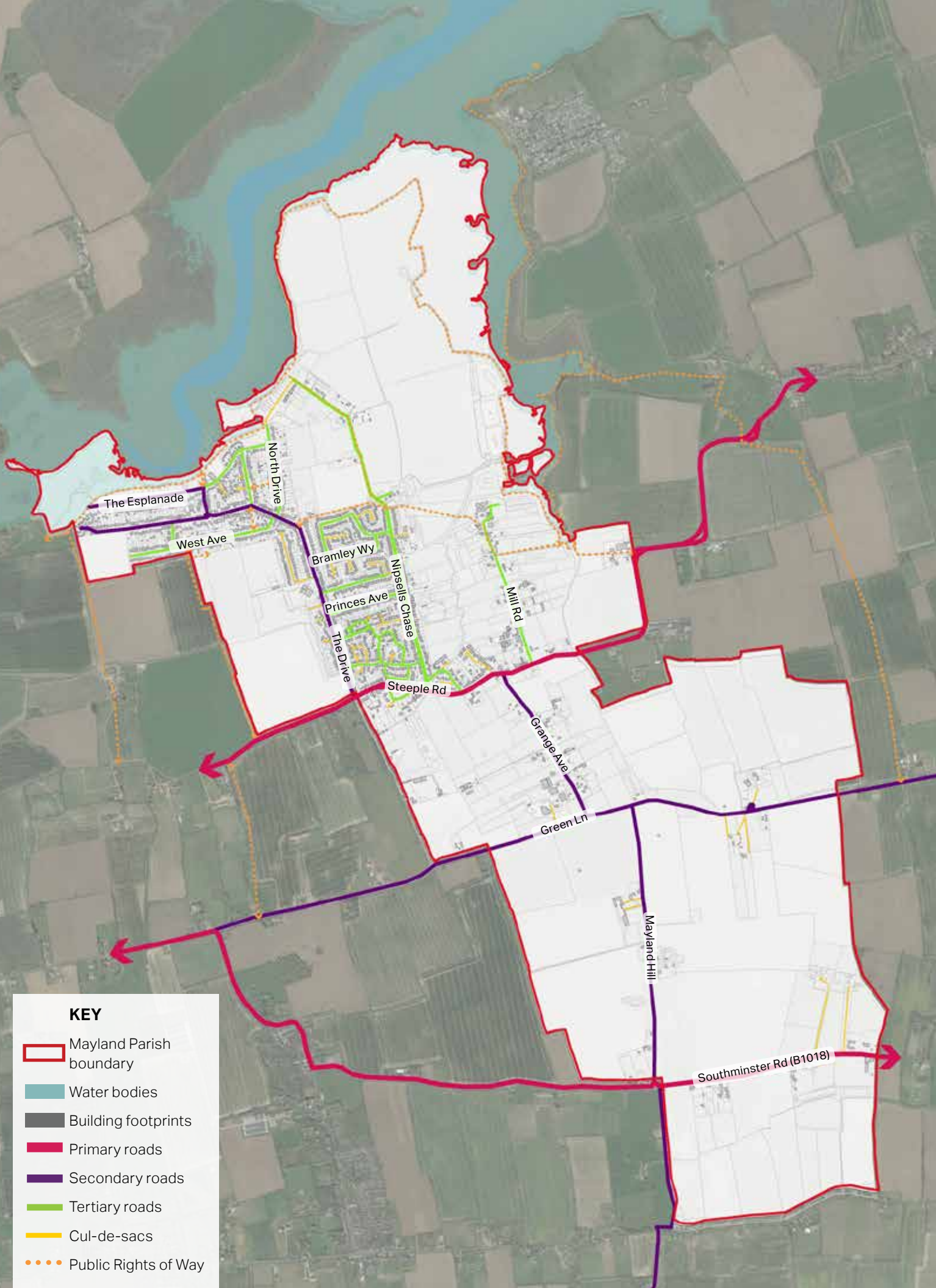

**KEY**

- Mayland Parish boundary
- Water bodies
- Building footprints
- Primary roads
- Secondary roads
- Tertiary roads
- Cul-de-sacs
- Public Rights of Way

**F.10** Figure 10: Movement network of Mayland Parish.

### 3.3 Green and blue infrastructure

The Maldon District Landscape Character Assessment describes the landscape of Maldon as gently undulating farmland and open fields at the rear of coastal marshland, with distinctive long hedgerow boundaries that run on parallel axes along medium to large size rectilinear field patterns. The rolling topography of the area is consistently interspersed with visual links to the drained marshland and stretches of deciduous woodland.

Mayland Nature Reserve serves as an important piece of green infrastructure to local communities as well as a biodiversity asset to the area. Additionally, playing fields and play area adjacent to Lawlington Park are popular local community amenities. The Cardnell Brothers Memorial Field fronting onto Lawling Creek and Mayland Creek is another pleasant open space at the northern edge of the parish.

The northern part of Mayland Parish borders the Mundon Creek and Lawling Creek, and fall within the Blackwater Estuary Ramsar site, which is also designated as a SSSI. This offers the village with open aspect riverside frontages and views, as well as a prime location for boating with the Blackwater Marina, Maylandsea Bay Sailing Club and Harlow Blackwater Sailing Club located along the riverfront. However, limited public access points to the foreshore remains a major concern locally and there are aspirations to expand public ownership for the riverfront.



F.11



F.12



F.13

**Figure 11:** Bakersfield Walk located within Lawling Park behind The Drive.

**Figure 12:** View over Lawling Creek from Blackwater Bistro seating.

**Figure 13:** As part of the Blackwater Estuary, Mayland is characterised by landscape features such as salt marshes and mudflats.



**KEY**

- Mayland Parish boundary
- Building footprints
- Water bodies
- Open fields
- Green space/play area
- Deciduous woodlands
- Playing fields
- Churchyard
- Salt marsh
- Mudflats
- Roads
- Public Rights of Way

**F.14** Figure 14: Green and blue infrastructure of Mayland Parish.

### 3.4 Topography and flood risk

The rolling topography of Mayland Parish is interspersed with visual links to the drained marshland. The main settlement area of the parish has a fairly flat topography, which rises from the village to higher ground in the south-east ranging from 2m to 50m above sea level.

Mayland Creek and Lawling Creek, as part of the River Blackwater Estuary, run along the north parish. Much of the northeastern part of the parish falls within Flood Risk Zone 3 where there is a high risk of flooding. This could affect properties that are fronting onto the riverfront. Parts of the Flood Risk Zone 3 also extends towards the south of the village, mainly along Nipsells Close, posing a flood risk for properties in the vicinity. However, the parish benefit from sea wall protection of low land along Lawling creek and Mayland Creek.



F.15



F.16



F.17

**Figure 15:** Rolling topography in Mayland opening up to long views towards the open countryside.  
**Figure 16:** Houses along The Esplanade fronting onto the river could be affected by surface water flooding during storm events.  
**Figure 17:** George Cardnell Memorial Field, located at the edge of the village settlement.

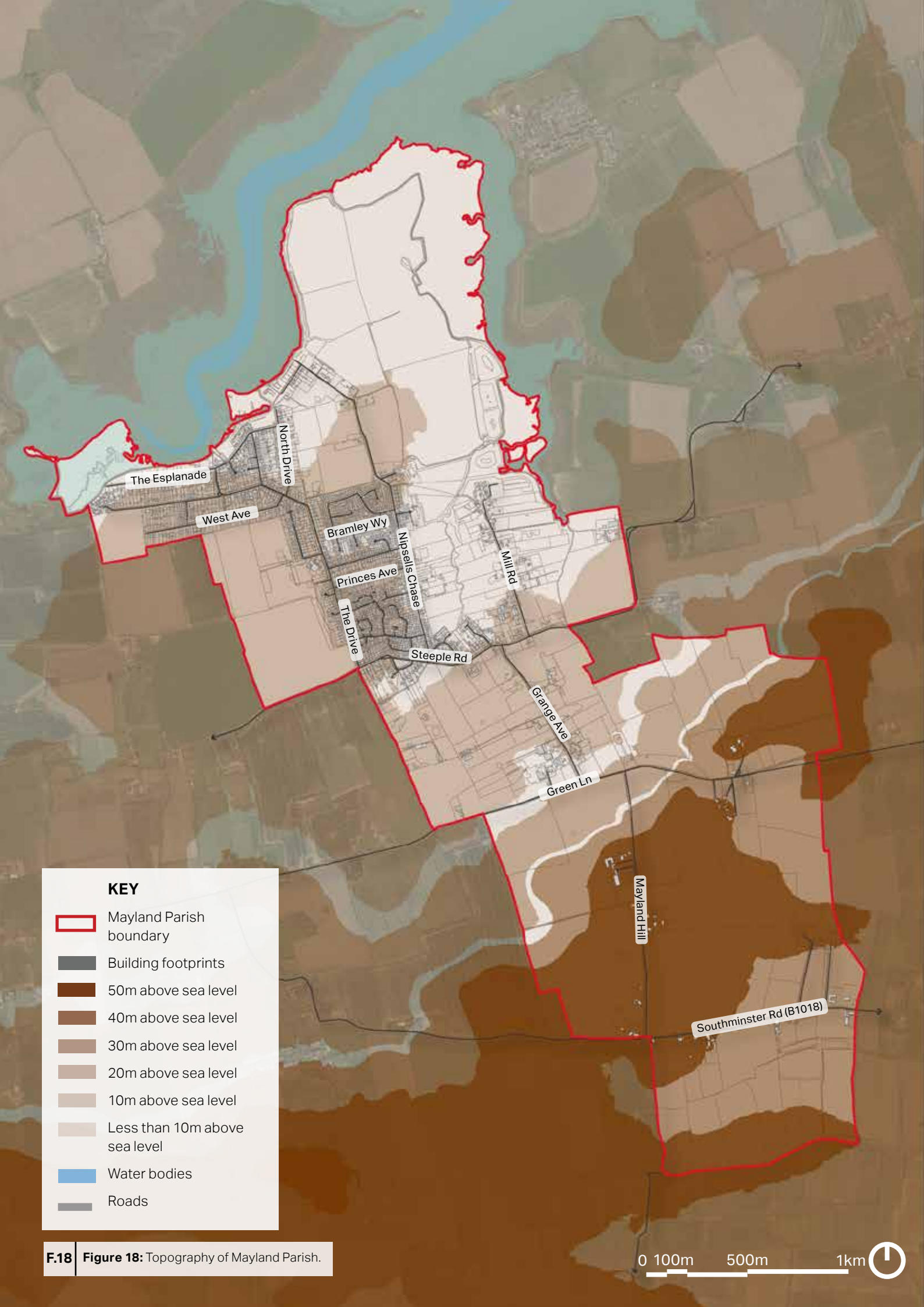

**KEY**

- Mayland Parish boundary
- Building footprints
- 50m above sea level
- 40m above sea level
- 30m above sea level
- 20m above sea level
- 10m above sea level
- Less than 10m above sea level
- Water bodies
- Roads

**F.18** Figure 18: Topography of Mayland Parish.

0 100m 500m 1km

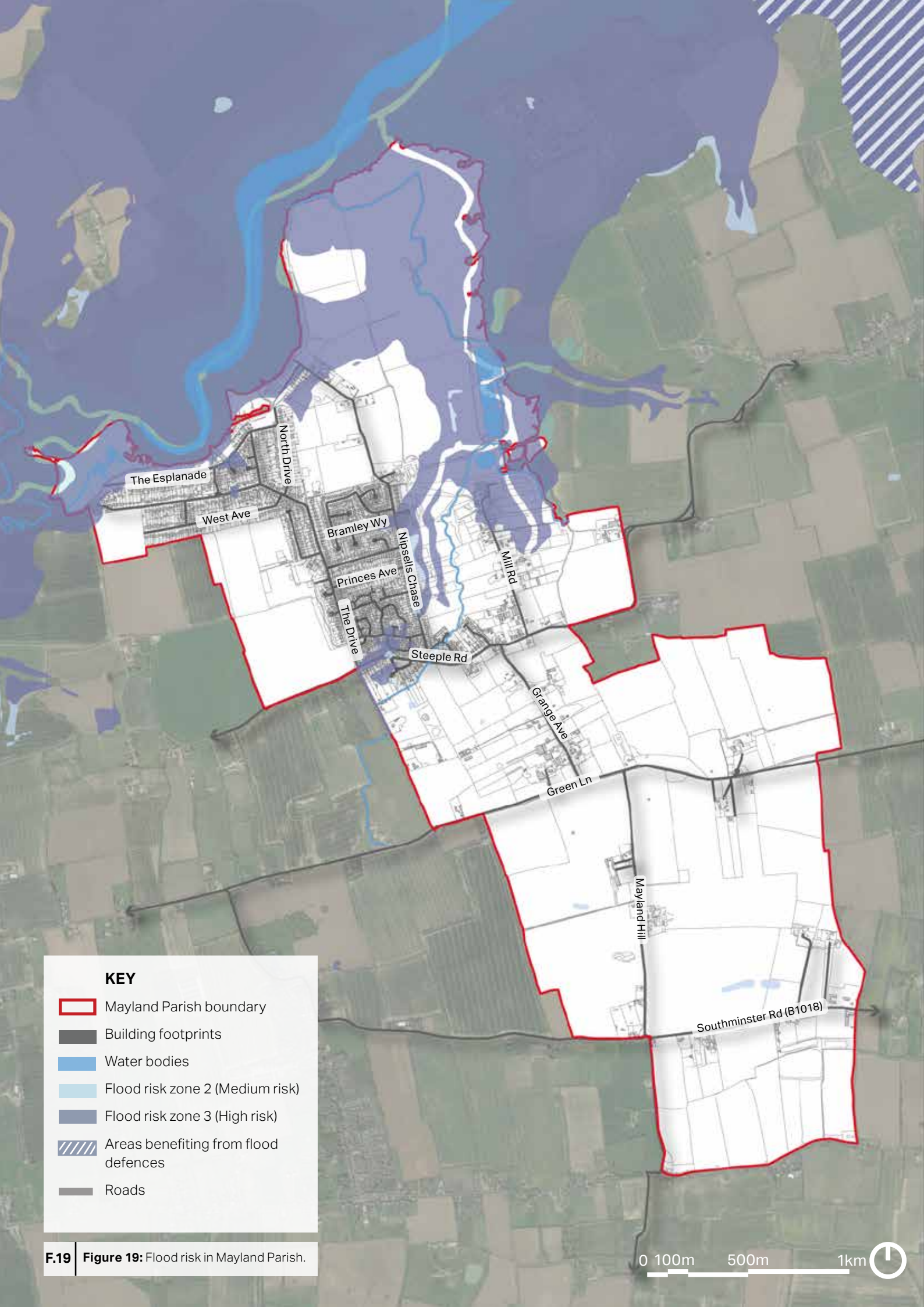

**KEY**

- Mayland Parish boundary
- Building footprints
- Water bodies
- Flood risk zone 2 (Medium risk)
- Flood risk zone 3 (High risk)
- Areas benefiting from flood defences
- Roads

**F.19** Figure 19: Flood risk in Mayland Parish.



Design guidance and  
codes

04

## 4. Design guidance and codes

**This chapter provides guidance on the design of development, setting out the expectations that applicants for planning permission in the parish will be expected to follow.**

### 4.1 Introduction

The following section describes a set of design codes that have been put together based on the existing context of Mayland. These are relevant to the whole Neighbourhood Area.

These codes will aim to guide any changes or development within the village to ensure the local character is respected whilst still allowing space for innovation within the built environment.

Detail about the structure of the codes is provided in Section 4.1.3. Both national and district guidance documents, such as those outlined in Section 2.1, should be read in conjunction with these codes. These codes support these documents and should not be considered in isolation.



F.20

**Figure 20:** The ten characteristics of well-designed places. (Source: National Design Guide, page 8).

### 4.1.1 The importance of good design

As the NPPF (paragraph 126) notes, “good design is a key aspect of sustainable development, creates better places in which to live and work and helps make development acceptable to communities”.

Research, such as for the Government’s Commission for Architecture and the Built Environment (now part of the Design Council) has shown that good design of buildings and places can:

- Improve health and well-being;
- Increase civic pride and cultural activity;
- Reduce crime and anti-social behaviour; and
- Reduce pollution.

This document seeks to harness an understanding of how good design can make future development as endearingly popular as the best of what has gone before.

### 4.1.2 Placemaking and design codes

These design codes are underpinned by a set of placemaking principles that should influence the design of future development areas, public realms, homes and green spaces, and the interfaces between them.

What designers and planners call ‘placemaking’ is about creating the physical conditions that residents and users find

attractive and safe, with good levels of social interaction and layouts that are easily understood.

The placemaking principles set out in the following pages should be used to assess the design quality of future development or regeneration proposals. These key principles should be considered in all cases of future development as they reflect positive placemaking and draw on the principles set out in many national urban design best practice documents including the National Design Guide, Building for a Healthy Life and the Urban Design Compendium.

The guidelines developed in this part focus on residential environments. However, new housing development should not be viewed in isolation, but considerations of design and layout must be informed by the wider context.

The local pattern of lanes and spaces, building traditions, materials and the natural environment should all help to determine the character and identity of a development.

It is important with any proposal that full account is taken of the local context and that the new design embodies the ‘sense of place’.

Reference to context means using what is around, shown in the first three sections, as inspiration and influence and it could be a contemporary solution that is in harmony with the surroundings.

### 4.1.3 Structure of the design codes

Based on the understanding of the parish gained in the previous sections, this section will identify design codes for future development to adhere to. As identified in the diagnostic report, the following design codes have been created to apply to the whole Neighbourhood Area.

Theme	Code	Title
<b>Settlement layout (SL)</b>	SL 01	Patterns of development
	SL 02	Layout of buildings
<b>Streets and parking (SP)</b>	SP 01	Prioritise walking and cycling
	SP 02	People-friendly streets
	SP 03	Car parking solutions
	SP 04	Trees and landscaping
	SP 05	Street lighting and dark skies
<b>Built form (BF)</b>	BF 01	Overlook public space
	BF 02	Define front and back gardens
	BF 03	Maintain a consistent building line
	BF 04	Density
	BF 05	Desired height profile
	BF 06	Establish a consistent property boundary
	BF 07	Extension and conversions
	BF 08	Architecture details, materials and colour palette
	BF 09	Corner treatment
<b>Environmental and energy efficiency (EE)</b>	EE 01	Features in dwellings
	EE 02	Flood mitigation
	EE 03	Wildlife friendly features

# SL. Settlement layout

## SL 01 PATTERNS OF DEVELOPMENT

Mayland has a nucleated development pattern with recent developments evolving around Imperial Avenue and The Drive. Any new development should respect the following principles:

- Development proposals should respect the nucleated settlement pattern, which provides quick access to the countryside or waterfront for all residents; and
- Residential development with a hard edge, which imposes an abrupt transition from the settlement to the surrounding countryside, should be avoided.

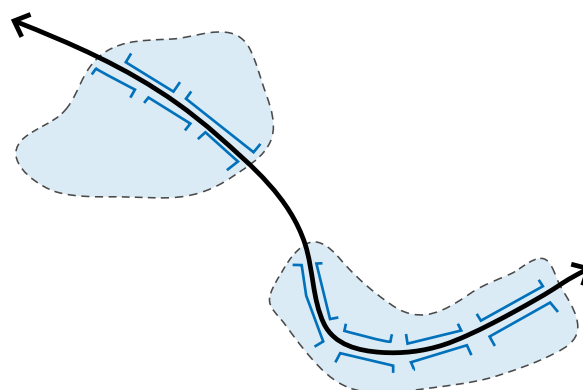

F.21



F.22

**Figure 21:** Diagram showing a nucleated development pattern.  
**Figure 22:** Mayland pattern of development. The core development formed along Imperial Avenue and The Drive. The rest of development formed along lanes leading to these main routes

## SL 02 LAYOUT OF BUILDINGS

The parish owes much of its character to the historic pattern and layout of both the settlement and individual buildings. New developments should respect the particular building patterns of each settlement in order to contribute positively to their character. In particular:

- Development should adopt the enclosure characteristics demonstrated in the village. New development should strive to knit in with the existing form of the settlement by adopting similar characteristics;
- Development should be considered strategically at the settlement level and should not be considered in isolation;
- New development should be planned to be permeable, promoting active travel at all times, providing plentiful non-vehicular connections;

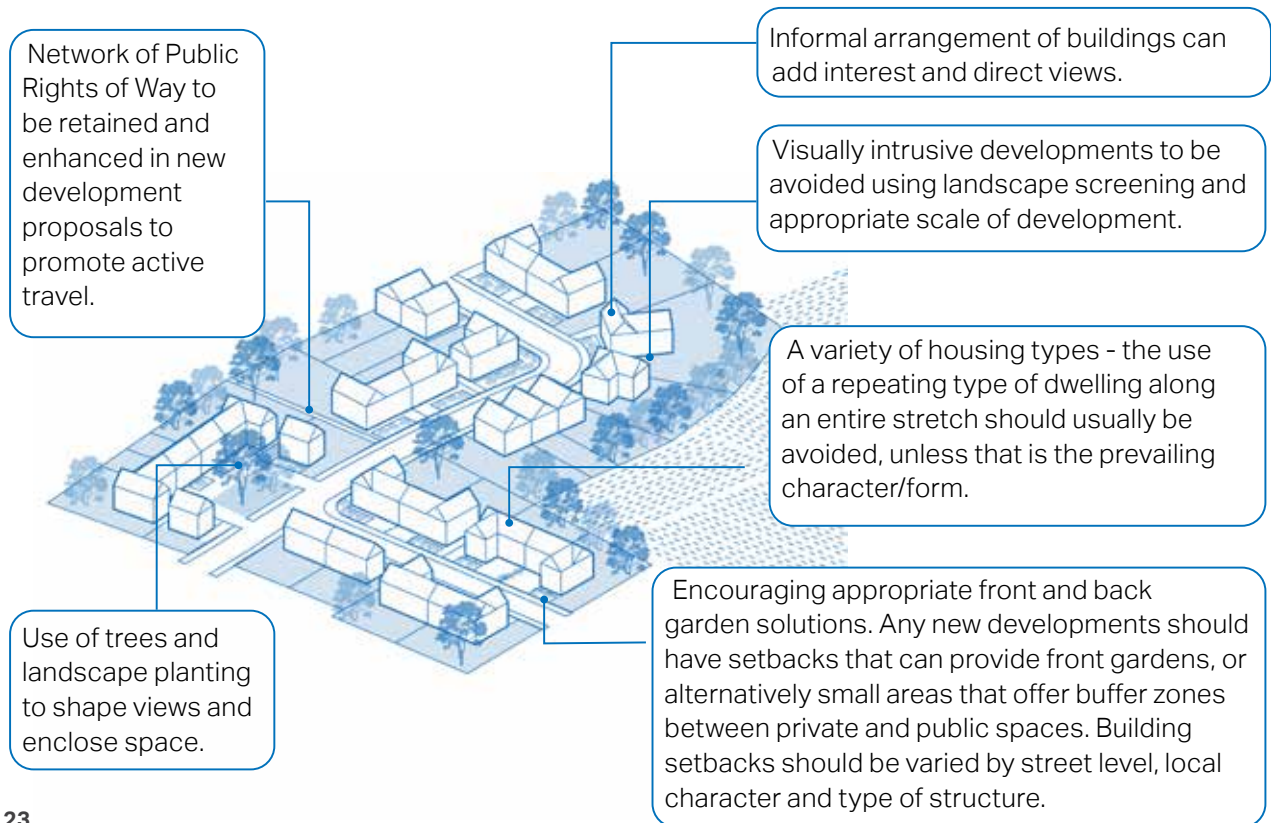

F.23

**Figure 23:** Diagram showing layout of building elements such as enhancing the Public Rights of Way network, respecting views, and front and back garden solutions, which could positively contribute to local character

- Layout, clustering and massing should take precedent from the best examples of development within the surrounding context. This page illustrates some precedent examples from the existing Neighbourhood Area; and
- New development should respond to site specific micro-climates and sun paths and use these as key design drivers to increase the environmental comfort for building users, both internally and externally.

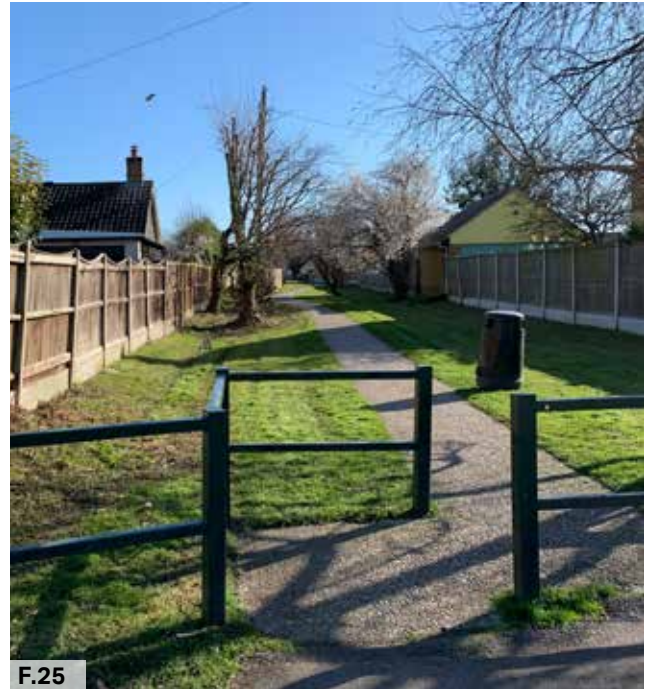

F.25



F.24



F.26

**Figure 24:** Buildings with various set back on Marine Parade.  
**Figure 25:** Gladwell Walk connecting Imperial Avenue to West Avenue.  
**Figure 26:** Use of different house typologies along a stretch of a road to add interest to the area.

## SP. Streets and parking

The following pages set out guidance to consider when developing both existing and new development within Mayland. They apply to the whole Neighbourhood Area. New development should have regard to the Essex Design Guide - Highways Technical Manual<sup>1</sup>, in particular the Streets & Roads and Parking sections.

### SP 01 PRIORITISE WALKING AND CYCLING

There is a good number of footpaths and footways in Mayland. New developments should introduce well connected and attractive pedestrian and cycling routes to encourage residents to use walking and cycling as their preferred way of travelling within the village. Some guidelines for future development are:

- Varied links should be enabled and created to favour pedestrian and cycle movement. This means that streets should be connected with each other and different travel options and routes should be considered. The connectivity should improve between the village, riverside and surrounding countryside through establishing multifunctional greenways promoting active travel and contributing to health and wellbeing.
- Good practice favours a generally connected street layout that makes it easier to travel by foot, cycle and public transport. To provide a sense of safety, these routes should benefit from natural surveillance, good sightlines and unrestricted views, and activity. This connected pattern creates a

'walkable neighbourhood'; a place where streets are connected and routes link meaningful places together;

- The greatest asset of Mayland is the open aspect riverside frontage walk, views and boating. Any new future walking/cycling links should take into account connections to the riverside and key features/destinations;
- All newly developed areas must provide direct and attractive footways between neighbouring streets and local facilities. Streets must be designed to prioritise the needs of pedestrians and cyclists. Establishing a robust pedestrian network, both across new development and amongst existing developments, is key to achieving good levels of connectivity in Mayland;
- A well-connected network pattern should be introduced to new development areas and a cul-de-sac pattern should be avoided;
- A connected street network at all levels provides people with a choice of different routes and generally allows traffic to be distributed more evenly across the network rather than concentrated onto heavily trafficked roads;
- Design features such as barriers to vehicle movement, gates to new developments, or footways between high fences must be avoided.
- Short and walkable distances are usually defined to be within a 10-minute walk or a 5 mile cycle. If the design proposal calls for a new street or cycle/pedestrian

<sup>1</sup> Essex Design Guide - Highways Technical Manual. Available at <https://www.essexdesignguide.co.uk/design-details/highways-technical-manual/>

link, it must connect destinations and origins. In addition, connected streets must provide a safe and pleasant environment at all times; and

- The Police Secured by Design Guidelines<sup>2</sup> warn against the “security of development being compromised by excessive permeability, for instance by allowing the criminal legitimate access to the rear or side boundaries of dwellings, or by providing too many or unnecessary segregated footpaths”.

2. Police Secured by Design Guidelines. Available at: <https://www.securedbydesign.com/guidance/design-guides>



**Figure 27:** An example of a layout which is mainly dominated by cul-de-sacs encourages reliance on cars for local journeys and blocks pedestrian flow.



**Figure 28:** Local example of a cul-de-sac road, Mayland Quay, which does not allow any further connection to the main road network.



**Figure 29:** An example of a connected layout, with some cul-de-sacs, balances sustainability and improves the sense of a walkable neighbourhood.

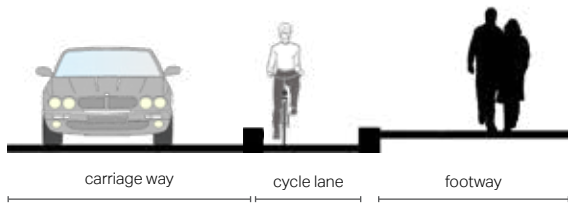

**Figure 30:** Local example of a permeable road, Drake Avenue, which connects The Drive to Nipsells Chase

## SP 02 PEOPLE-FRIENDLY STREETS

It is essential that the design of new development includes streets and junctions that incorporate the needs of pedestrians, cyclists, and, if applicable, public transport users, having regard to the standards set out in the Essex Design Guide - Highways Technical Manual. Some guidelines for future development are:

- New streets should be linear with gentle meandering, providing interest and evolving views while helping with orientation. Routes must be laid out in a connected pattern allowing for multiple connections and choice of routes, particularly on foot. Cul-de-sacs must be relatively short and provide onward pedestrian and cycle links;
- Within the settlement boundaries, streets must not be built to maximise vehicle speed or capacity. Streets and junctions must be designed with the safety and accessibility of vulnerable groups in mind, such as children and wheelchair users, and may introduce a range of traffic calming measures;
- Streets must incorporate opportunities for street trees, multifunctional green infrastructure and sustainable drainage;
- Swales could also be inserted into the landscaping to provide sustainable drainage solutions. Swales are shallow, broad and vegetated channels designed to store and convey runoff. They are easy to incorporate into landscaping and the maintenance cost is low;
- Where appropriate, cycle routes should be incorporated into street design to encourage people to use active and sustainable transport;
- Traffic calming should be achieved by design using landscaping, street parking and building layout, and avoid using the traditional forms of engineered traffic calming like humps, cushions and chicanes;
- Crossing points that are safe, convenient, and accessible for pedestrians of all abilities must be placed at frequent intervals on pedestrian desire lines and at key nodes;
- Junctions must enable good visibility between vehicles and pedestrians. For this purpose, street furniture, planting, and parked cars must be kept away from visibility splays to avoid obstructing sight lines;
- At junctions with minor roads, the carriageway surface should be raised across a pedestrian crossing to prioritise pedestrian movement;
- Sufficient width of footway should be provided to facilitate a variety of mobilities, such as young family with buggies, mobility scooter, wheelchairs, etc. The Essex Design Guide requires footways to be a minimum of 2 metres wide and should only be narrower in exceptional circumstances; and
- New street design should include dedicated areas for cycle parking having regard to Maldon District Council Vehicle Parking Standards SPD, or any successor document.



F.31

Figure 31: Cross-section illustrating a segregated cycleway.

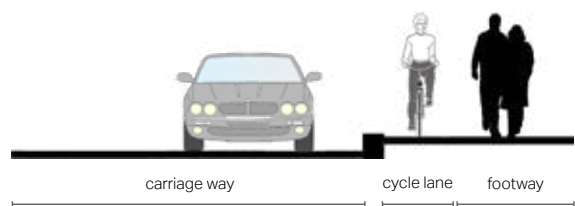

F.33

Figure 32: Cross-section illustrating a shared cycleway.



F.32

Figure 33: Local example of a gently meandering street that creates an interesting visual result for pedestrians and drivers.



F.34

Figure 34: Local example of a residential street that hosts green verges, bushes and occasional trees.

### Residential Street Type 1

Some guidelines for this type of residential street are:

- This residential streets provide access between main streets and neighbourhoods. They should emphasize the human scale and be designed for lower traffic volumes compared to primary streets;

- These streets should accommodate carriageways wide enough for two-way traffic and on-street parallel car parking bays. On-street parking may be on or accommodated on the street or inset into green verges;
- Carriageways should be designed to be shared between motor vehicles and cyclists. Green verges should be proposed along the streets; and
- Where possible, these streets should be lined by large street trees on both sides.

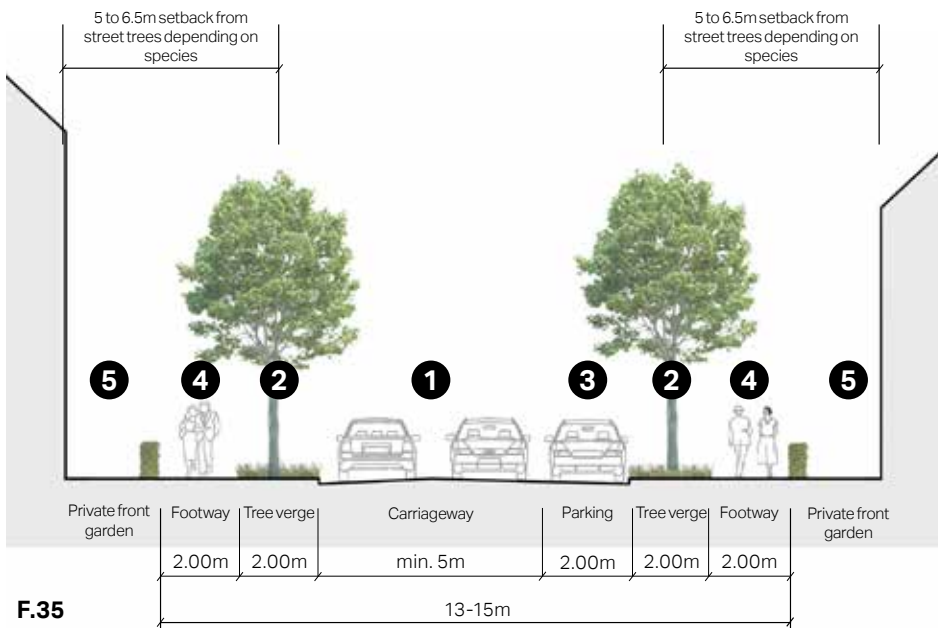

1. Shared carriageway (neighbourhood traffic). Traffic calming measures may be introduced at key locations if needed.
2. Green verge with large street trees. The latter are optional but would be positive additions.
3. Parking bay (may also be inset into verges).
4. Footway - utilities typically located underneath.
5. Residential frontage with boundary hedges and front gardens.

F.35



F.36

**Figure 35:** Cross-section to illustrate some guidelines for a Residential Street Type 1.  
**Figure 36:** Imperial Avenue as one of the main roads in Mayland.

## Residential Street Type 2

Some guidelines for this type of residential street are:

- These streets have a strong residential character and provide direct access to residences from streets that are Residential Street Type 1. They should be designed for low traffic volumes and low speeds, ideally 20 mph;
- Carriageways should accommodate two-way traffic, cyclists and parking

bays. These streets should also accommodate footways, with a 2m minimum width on both sides, and must be designed for cyclists to mix with motor vehicles;

- These streets should be formed with a high degree of built form enclosure, with consistent building lines and setbacks; and
- Small street trees should be provided with suitable gaps, wherever possible.

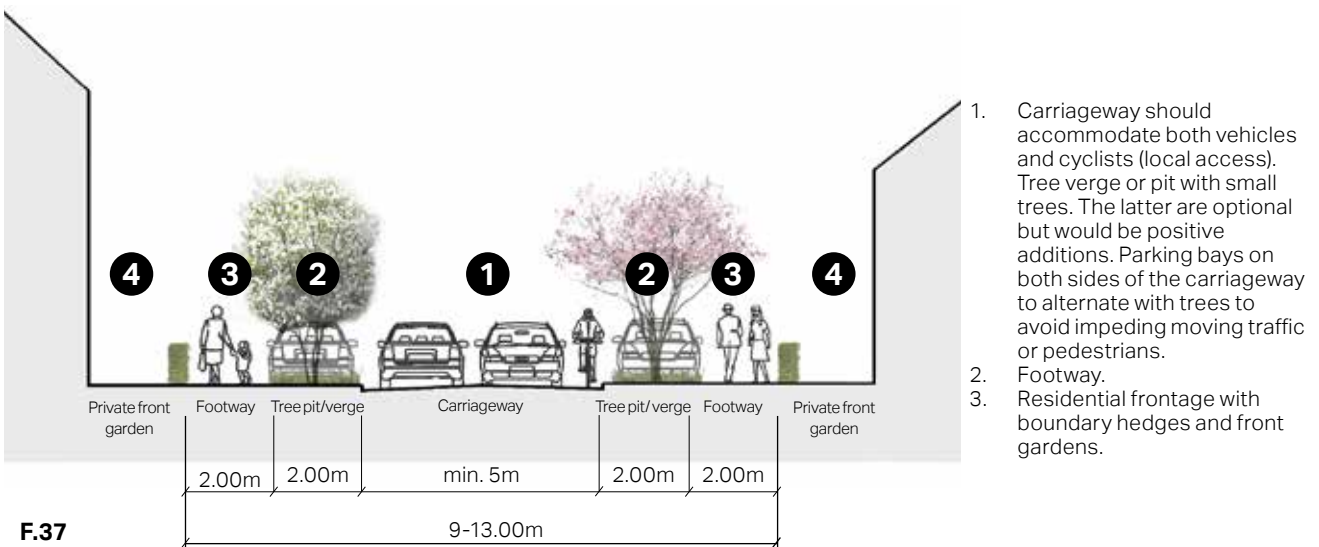

F.37



F.38

**Figure 37:** Cross-section to illustrate some guidelines for a Residential Street Type 2.  
**Figure 38:** Local example of a Residential Street Type 2, West Avenue.

## Edge Lane

All the edges of new development areas in Mayland should be served by continuous Edge Lanes to provide high level of connectivity. Some guidelines for this type of street are:

- Edge Lanes are low-speed and low-traffic streets that front houses with gardens on one side and a green space on the other. Carriageways typically consist of a single lane of traffic in either direction, and are shared with cyclists;
- The lane width can vary to discourage speeding and introduce a more informal and intimate character. Variations in paving materials and textures can be used instead of kerbs or road markings; and
- Edge Lanes should be continuous providing high level of connectivity and movement. Cul-de-sacs must be avoided.



1. Shared lane (local access) - width to vary.
2. Green verge with trees. It is optional but would be positive additions. Parking bays to be interspersed with trees to avoid impeding moving traffic or pedestrians.
3. Residential frontage with boundary hedges and front gardens.
4. Green space and potential for implementing swales into the landscaping.



**Figure 39:** Cross-section to illustrate some guidelines for Edge Lanes.

**Figure 40:** Examples of an Edge Lane, UK.

### Green Links

Some guidelines for Green Links are:

- Green links should be located within minimum 7.5m wide corridor adjacent to retained hedgerows, trees and woodlands;
- Existing retained trees, hedgerows and woodland to be managed to allow clear access for pedestrians and cyclists along the corridor whilst retaining existing character and habitat structure;
- Trees, shrubs and grass to be established within the corridor to reflect character area, and maintain and enhance habitat;

- Shared or segregated footpath and cycleway to be provided within corridor;
- Footpath and cycleway to be hard surfaced and constructed of bound material which may also combine with vehicle access;
- Combined width of unsegregated footpath and cycleway to be a minimum of 3.0m; and
- Where required, SuDS features to be incorporated into corridor beside the surface of shared footpath and cycleway.

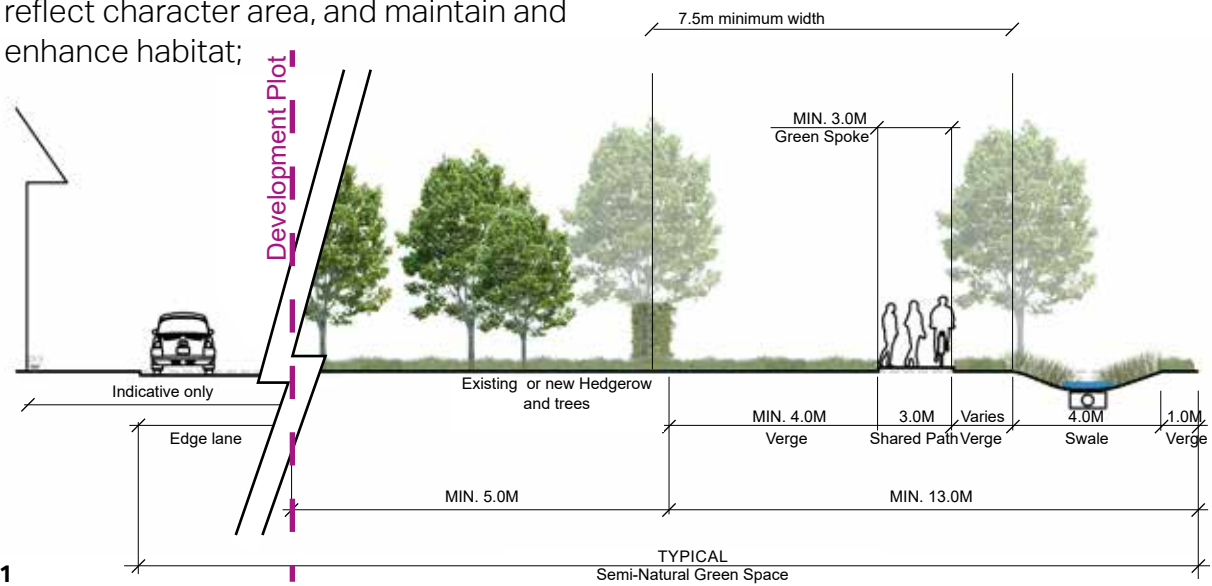

F.41



F.42

**Figure 41:** Section to illustrate some guidelines for green links.  
**Figure 42:** Example of a green link (source: <https://www.sustrans.org.uk/our-blog/opinion/2020/august/how-does-the-uk-government-s-gear-change-relate-to-the-national-cycle-network>).

## SP 03 CAR PARKING SOLUTIONS

Parking areas are a necessity but do not need to be unsightly or dominate streetscenes. New development should have regard to Maldon District Council Vehicle Parking Standards SPD, or any successor document.

- When placing parking at the front of a property, the area should be designed to minimise visual impact and to blend with the existing streetscape and materials. The aim is to keep a sense of enclosure and to break the potential of a continuous area of car parking in front of dwellings. This can be achieved by means of walls, hedging, planting and the use of quality paving materials;
- When needed, residential car parking can be translated into a mix of on-plot side, front, garage and courtyard parking, complemented by on-street parking;
- For family homes, it is preferable for cars to be placed at the side, or otherwise the front, of the property. For small pockets of housing, a rear court is acceptable;
- Car parking design should be combined with landscaping to minimise the presence of vehicles; and
- Parking areas and driveways should be designed to improve impervious surfaces, for example, through the use of permeable paving. Dwellings with 1 or 2 bedroom should provide at least 1 on-plot parking space. Dwellings with 3 or more bedrooms should provide 2 on-plot parking spaces.



F.43



F.44

**Figure 43:** On-street parking in front of shops along Imperial Avenue.

**Figure 44:** On-plot parking on Imperial Avenue.

## On-street Parking

In order to reduce visual impacts on the street, on-street parking as the only means of parking should be avoided in future development wherever possible. Off-street parking should be encouraged within the village instead.

- On-street parking must be designed to avoid impeding the flow of pedestrians, cyclists and other vehicles, and can serve a useful informal traffic calming function;
- On low-traffic residential streets or lanes that are shared between vehicles and pedestrians, parking bays can be clearly marked using changes in paving materials instead of road markings; and
- Opportunities must be created for new public car parking spaces to include electric vehicle charging points. Given the move towards electric vehicles, every opportunity must be taken to integrate charging technologies into the fabric of the road and street furniture in both the public and private realms.

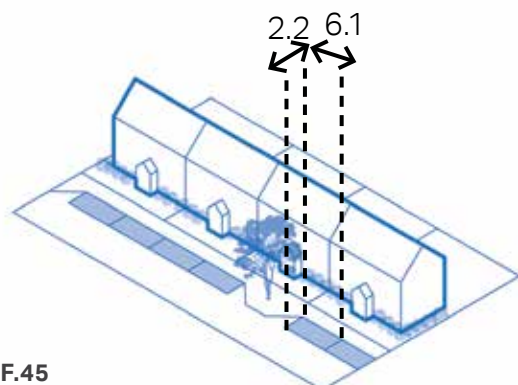

F.45



F.46

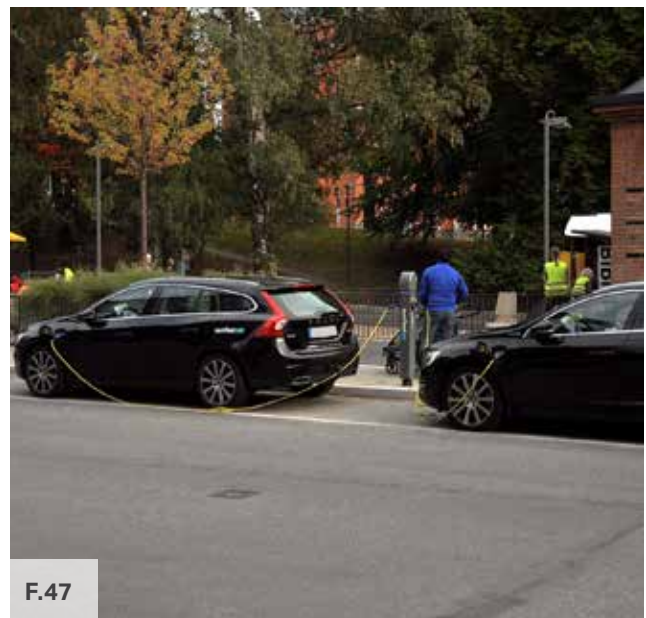

F.47

**Figure 45:** Illustrative diagram showing an indicative layout of on-street parking.

**Figure 46:** On-street parking on Imperial Avenue.

**Figure 47:** Inset on-street parking with electric vehicle charging points.

### On-plot Side or Front Parking

- Parking provided on driveways directly in front of dwellings should be restricted due to the visual impact that cars have on the street. Therefore, a maximum of 2 dwellings in a row will be permitted to provide parking in this way. Front gardens should be a minimum depth of 6m to allow movement around parked vehicles and also be well screened with hedgerows when providing parking space to the front of a dwelling; and
- Parking being provided on a driveway to the side of a dwelling should be of sufficient length (5m minimum) so that a car can park behind the frontage line of the dwelling. This will reduce the visual impact that cars will have on the street scene. When parking is provided to the side of a dwelling a minimum front garden depth of 3m should be provided.

3m minimum front garden should be provided in front of any new dwellings.

A minimum of 5m should be allocated to the length of side parking.

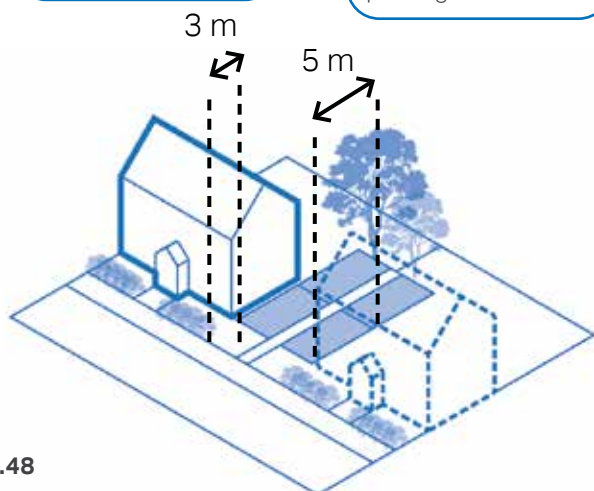

F.48

Figure 48: Illustrative diagram showing an indicative layout of on-plot side parking.



F.50

Figure 50: On-plot front parking on The Drive.



F.51

Figure 51: On-plot side parking on Mayland Quay.

A minimum of 6m should be allocated to the length of on-plot parking

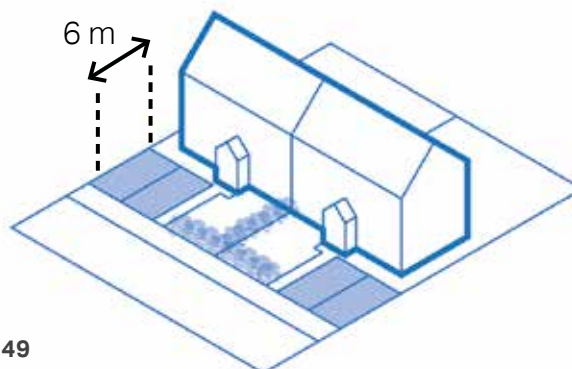

F.49

Figure 49: Illustrative diagram showing an indicative layout of on-plot front parking.

### Garage Parking

- Garages must not dominate the appearance of dwellings and must not reduce the amount of active frontage to the street; and
- They should provide minimum 3.5m x 7m internal space to park a car and provide space for storage to avoid the garage to be used for storage purposes only.



F.52

Figure 52: Illustrative diagram showing an indicative layout of on-plot garage parking

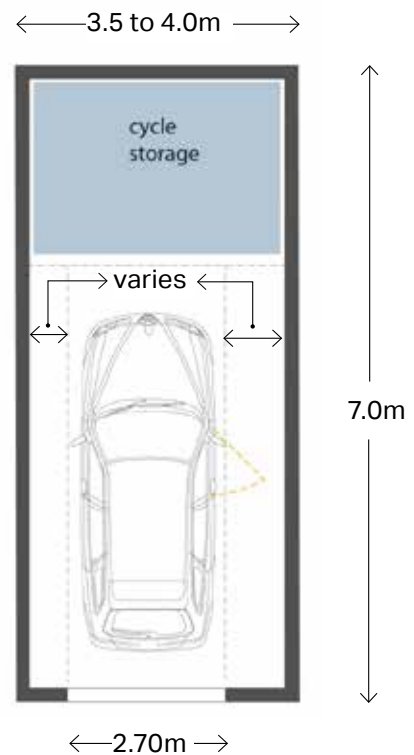

F.53

Figure 53: Indicative layout of a garage with a cycle storage area.

## SP 04 TREES AND LANDSCAPING

Trees provide shading and cooling, absorb carbon dioxide, act as habitats and green links for species, reduce air pollution and assist water attenuation and humidity regulation. For people, they help alleviate stress and anxiety, help with recovery from ill-health and create a sense of positive mental health and well-being. In addition, they add life to the landscape and help shape and add character to open spaces.

There are different green spaces which need to be protected such as Nipsells Chase Scrub, Bakers Field park, Lawling Park and sports ground. The quality of these public spaces and green areas should be improved as they are important places for civic life and activity.

The following guidelines focus on the design aspects and appearance of planting and trees in private gardens as well as public open spaces and streets.



**F.54**

**Figure 54:** An indicative diagram showing green spaces and landscape planting

## Planting Standard

- Aim to preserve existing mature trees, incorporating them into the new landscape design and using them as accents and landmarks, where appropriate;
- Consider canopy size when locating trees. Reducing the overall number of trees but increasing the size of trees is likely to have the greatest positive long-term impact;
- Size of tree pits should allow sufficient soil around the tree. Ensure tree stems are in the centre of the verge to provide a 1m clearance of the footway or carriageway;
- Tree root zones should be protected to ensure that trees can grow to their mature size. Root barriers must be installed where there is a risk of damaging foundations, walls and underground utilities;
- New trees should be added to strengthen vistas, focal points and movement corridors, while retaining clear visibility into and out of amenity spaces. They should, however, not block key view corridors and vehicular circulation sight lines;
- New trees should be integrated into the design of new developments from the outset rather than left as an afterthought to avoid conflicts with above- and below-ground utilities;

- To ensure resilience and increase visual interest, a variety of tree species is preferred over a single one. Tree species should be chosen to reflect the prevailing character of the landscape, soil conditions and the associated mix of native species, but should also have regard to climate change, environmental/habitat benefits, size at maturity and ornamental qualities; and
- Regulations, standards, and guidelines relevant to the planting and maintenance of trees include:

- Trees in Hard Landscapes: A Guide for Delivery;<sup>1</sup>
- Trees in the Townscape: A Guide for Decision Makers;<sup>2</sup>
- Tree Species Selection for Green Infrastructure;<sup>3</sup> and
- BS 8545:2014 Trees: from nursery to independence in the landscape - Recommendations.<sup>4</sup>

<sup>1</sup> Trees & Design Action Group (2012). *Trees in Hard Landscapes: A Guide for Delivery*. Available at: [http://www.tdag.org.uk/uploads/4/2/8/0/4280686/tdag\\_trees-in-hard-landscapes\\_september\\_2014\\_colour.pdf](http://www.tdag.org.uk/uploads/4/2/8/0/4280686/tdag_trees-in-hard-landscapes_september_2014_colour.pdf)

<sup>2</sup> Trees & Design Action Group (2012). *Trees in the Townscape: A Guide for Decision Makers*. Available at: [http://www.tdag.org.uk/uploads/4/2/8/0/4280686/tdag\\_treesinthetownscape.pdf](http://www.tdag.org.uk/uploads/4/2/8/0/4280686/tdag_treesinthetownscape.pdf)

<sup>3</sup> Trees & Design Action Group (2019). *Tree Species Selection or Green Infrastructure*. Available at: [http://www.tdag.org.uk/uploads/4/2/8/0/4280686/tdag\\_treespeciesguidev1.3.pdf](http://www.tdag.org.uk/uploads/4/2/8/0/4280686/tdag_treespeciesguidev1.3.pdf)

<sup>4</sup> British Standards Institution (2014). *BS 8545:2014 Trees: from nursery to independence in the landscape - Recommendations*. Available at: <https://shop.bsigroup.com/ProductDetail/?pid=00000000030219672>

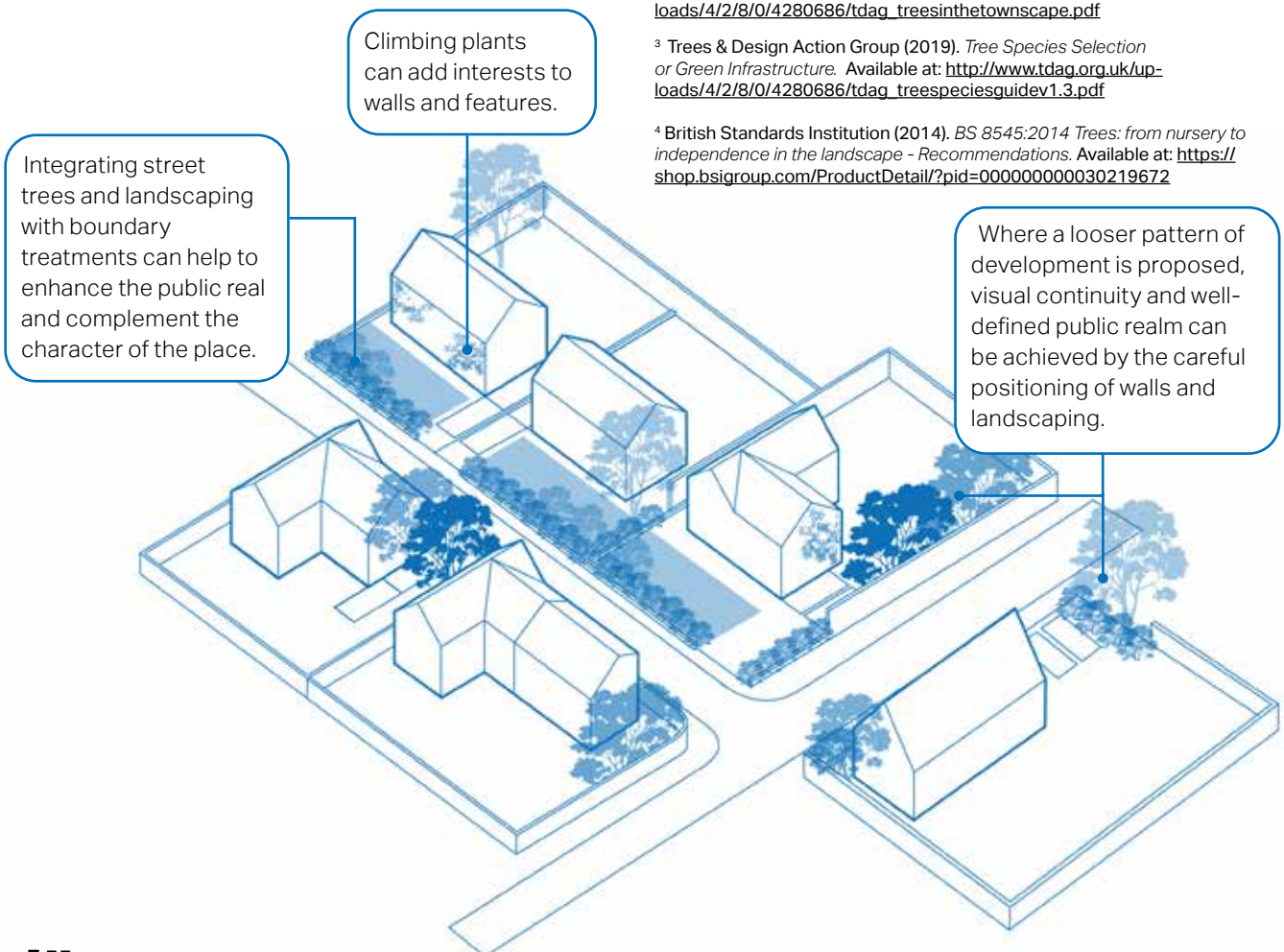

**F.55**

**Figure 55:** Diagram showing trees and landscaping that complement the public realm and create a sense of enclosure.

### **Give Spatial Enclosure, and Provide Screening and Privacy**

The use of hedges, hedgerows trees and walls contribute to the strong character of the area and a sense of enclosure. To respect the existing context, both the building and the boundary feature should be consistent with the prevailing character, although there should be some allowance for some variation to provide added visual interest.

- Existing hedges, hedgerow trees and walls should, wherever appropriate, be retained to contribute to this sense of enclosure. Additional or replacement hedges and trees should be planted to maintain the continuity of existing hedges and hedgerow tree cover; and
- Where appropriate and feasible, any new developments should have setbacks that allow for front gardens or else a small area to provide a planted buffer zone between the private space and public space.

### **Complement the Public Realm and Enhance the Built Environment and Local Identity**

Planting can make an appreciable difference to the appearance of an area, as well as enhancing the local identity.

- New development should use boundary features which are complementary to the street and enhance the character of the village. The use of trees, hedges and planting in publicly visible areas, including edges and interfaces, should be encouraged; and
- Climbing plants are good at screening features such as garages, blank walls and fences.

### **Form Focal Points and Frame Views**

In addition to the intrinsic value of trees, they can also have a practical use value. In a small-scale open space, trees provide a focal point of interest.



F.56

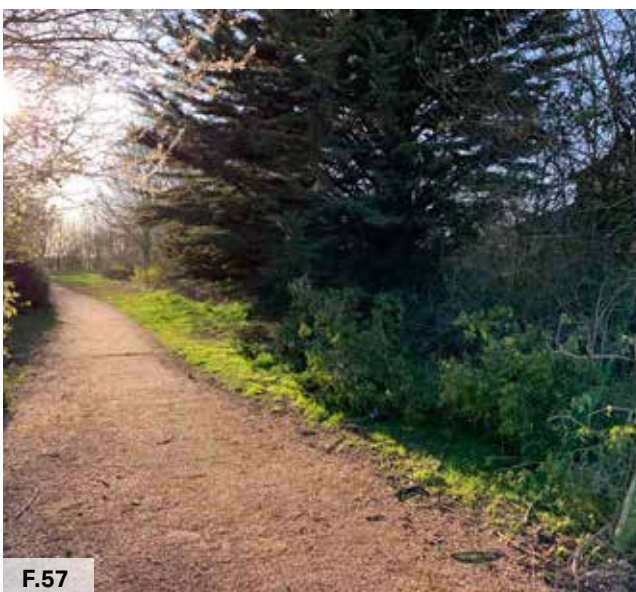

F.57



F.58

**Figure 56:** Mature trees add interest around the pond on Drake Avenue.

**Figure 57:** Mature trees along Bakersfield Path.

**Figure 58:** George Cardnell Memorial Field along LAWLING Creek.

### SP 05 STREET LIGHTING AND DARK SKIES

The 'dark skies' character of the countryside should be protected. Dark skies benefit both people and wildlife.

Any new development should minimise impact on the existing 'dark skies' within the settlements and reduce light pollution that disrupts the natural habitat and human health.

The following guidelines aim to ensure there is enough consideration given at the design stage:

- Street lighting should be avoided within areas of public realm, in line with the existing settlement character;
- Ensure that lighting schemes such as LED streetlights will not cause unacceptable levels of light pollution, particularly in intrinsically dark areas. These can be areas very close to the countryside or where dark skies are enjoyed;
- Residential lighting (i.e. on or around the property) is to be sympathetic with the location and be of low light levels so as to avoid excessive light pollution;

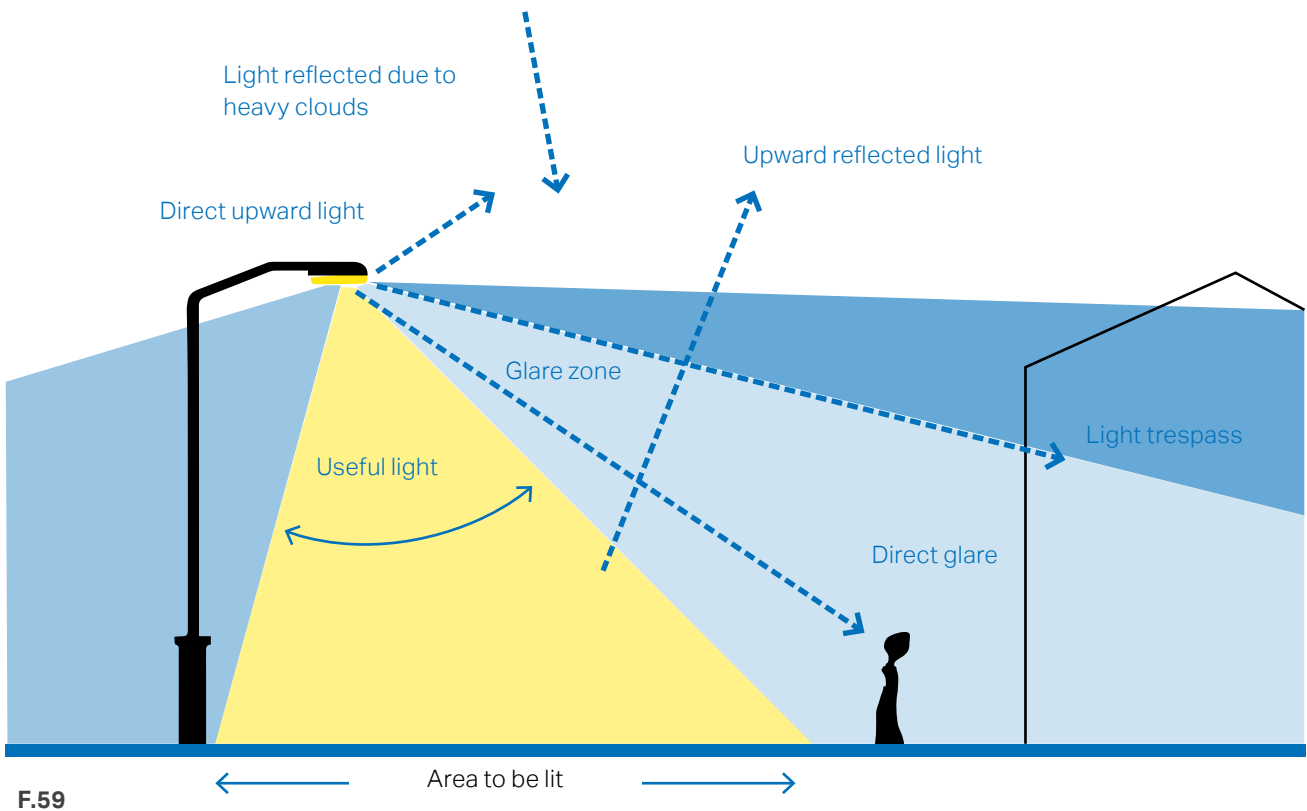

Figure 59: Indicative diagram to illustrate the different components of light pollution and what 'good' lighting means.

- Consider lighting schemes that could be turned off when not needed (i.e. 'part-night lighting') to reduce any potential adverse effects (e.g. when a business is closed or, in outdoor areas, switching off at quiet times between midnight and 5am or 6am). Planning conditions could potentially be used to enforce this. External lighting schemes should be PIR controlled and unnecessary lighting avoided;
- Impacts on sensitive wildlife receptors throughout the year, or at particular times (e.g. on migration routes), may be mitigated by the design of the lighting or by turning it off or down at sensitive times;
- Glare should be avoided, particularly for safety reasons. This is the uncomfortable brightness of a light source due to the excessive contrast between bright and dark areas in the field of view. Consequently, the perceived glare depends on the brightness of the background against which it is viewed. Glare is affected by the quantity and directional attributes of the source. Where appropriate, lighting schemes could include 'dimming' to lower the level of lighting (e.g. during periods of reduced use of an area, when higher lighting levels are not needed);
- The needs of particular individuals or groups should be considered, where appropriate (e.g. the safety of pedestrians and cyclists); and
- Any new developments and house extensions designs should encourage the use of natural light sources.

## BF. Built form

The following section outlines policies that should be considered by developers when creating new development within Mayland. Some of the following guidance is directed at development on existing plots, such as extensions, though many can be applied to both new and existing development.

In general, the historic form of parts in Mayland is of large plots and dwellings. While this is appropriate when development or redevelopment occurs in those areas, other newer areas should be developed in a coherent form with modern best practice. That is, there should be a proportional relationship between size of plot, dwelling and spaces between the dwellings. In general, Mayland exhibits low density development with heights averaging 1 to 2 storeys and a reasonable space between dwellings. The following illustrative diagrams show this intention and new proposals would need to demonstrate that this has been observed.

The structure of the following codes generally starts with policies on a larger scale and subsequently moves to codes related to specific built form details.



F.60



F.61

**Figure 60:** Semi-detached houses which are keeping with the local character on Imperial Avenue.

**Figure 61:** Two-storey detached houses with pitched roof and chimney stacks on Esplanade East.

## BF 01- OVERLOOK PUBLIC SPACE

In order to provide a sense of security and natural surveillance, the windowed front elevation of a dwelling should face the street where this is in keeping with local character. The rear boundaries facing the street should be avoided as this has a negative impact on the character of a street and reduces levels of security and natural surveillance. Rear boundaries should back on to other rear boundaries or provide a soft transition into the natural environment such as at the settlement edge.

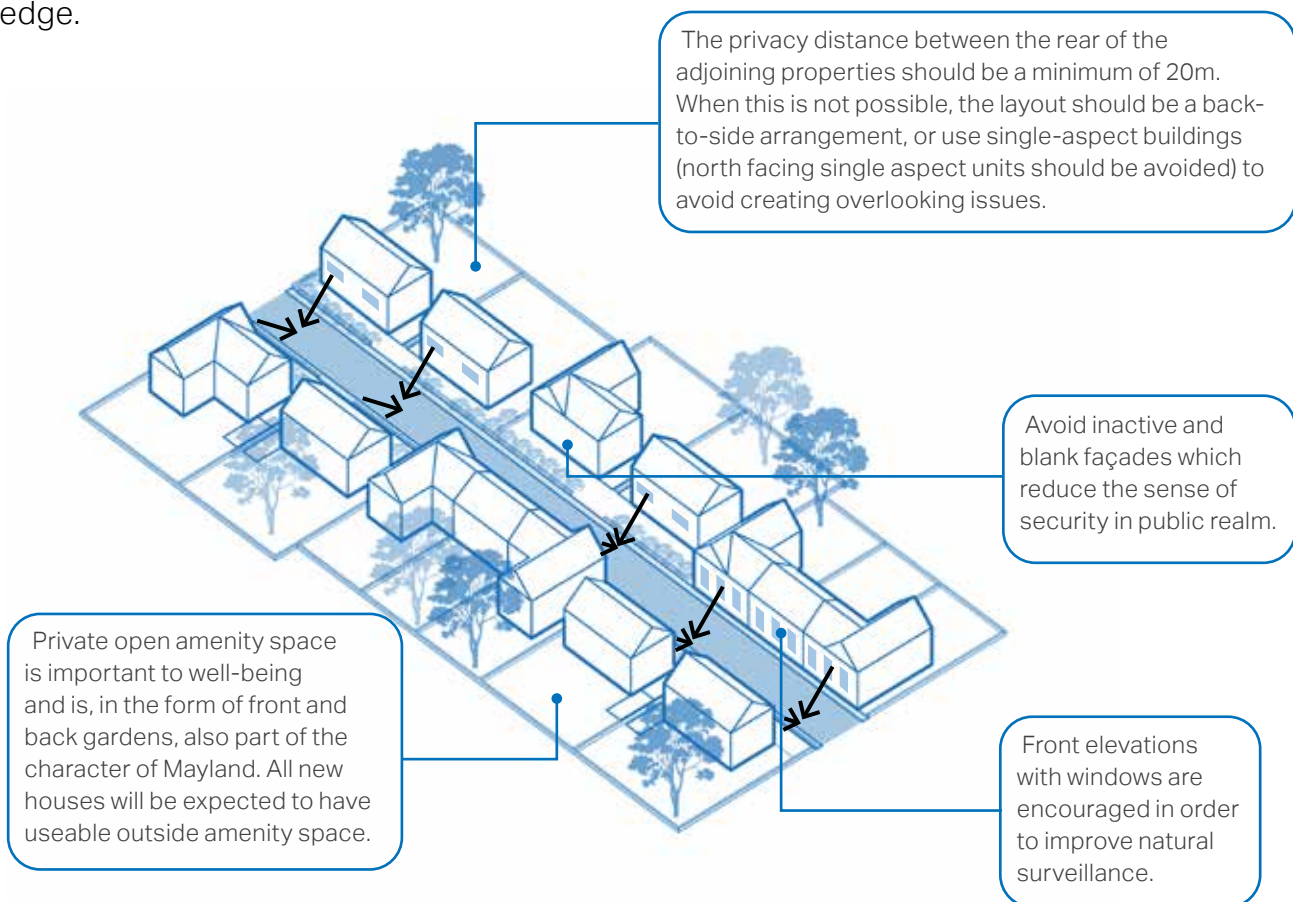

F.62

Figure 62: Diagram to highlight the importance of natural surveillance to improve the security

## BF 02 DEFINE FRONT AND BACK GARDENS

The ratio of garden space to built form within the overall plot is exceptionally important to ensure that the sense of openness and green space within the village is maintained.

There are different garden dimensions in each of the areas in Mayland. The majority of buildings have deep front gardens with reasonably sized back gardens. For example, The Esplanade has front gardens that range from 25 to 40m and back gardens from 10 to 25m.

Some properties between Nipsells Chase and The Drive's front and back garden sizes ranging from 2 to 5m and 5 to 15m, respectively. These garden sizes can be found in cul-de-sac developments such as Fels Way and Smiths Avenue.

Back gardens should be a minimum depth of 10m and provide a minimum area of 50m<sup>2</sup> of useable amenity space.

North facing back gardens should exceed 10m in length to ensure sunlight is maximised.

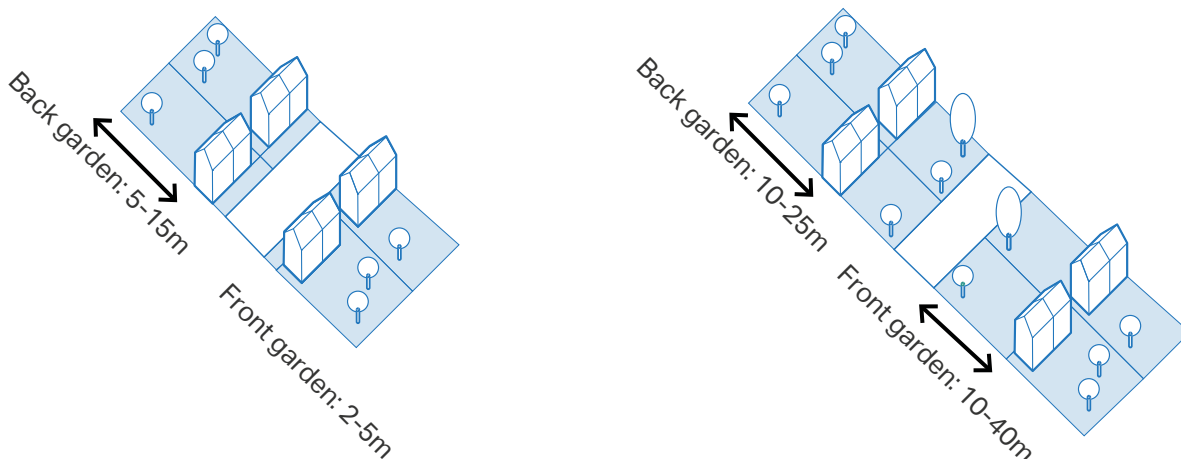

F.63

**Figure 63:** Different proportion of green space varied. From left (Smiths Avenue) and right (The Esplanade or Steeple Road). The majority of properties in Mayland follow the right diagram configuration with deep front and back gardens.

### BF 03 MAINTAIN A CONSISTENT BUILDING LINE

The use of continuous building lines and setback distances contribute to the overall character of the area and the sense of enclosure of the streets and public spaces. Continuous building lines with a minimum gap create a strong distinction between public and private spaces, and provide definition to the public realm. Where buildings are more generously set back from the carriageway, the threshold spaces should be well landscaped.

- To ensure sufficient street enclosure, private front thresholds should have a modest depth and accommodate a small garden or area for plantation;
- Low to medium densities in residential areas can vary setbacks in order to respond to the landscape context and the more open character of the area; and
- Front gardens can be much deeper where the topography requires so or to respond to the existing character area. It also helps to create a softer transition between countryside, green spaces and built environment.



**Figure 64:** Subtle changes in building lines with adequate front and deep back gardens on West Avenue.  
**Figure 65:** Subtle changes in building lines. Building lines follow the road layout and meander along Heron Way.  
**Figure 66:** Various setbacks along Steeple Road.

## BF 04 DENSITY

The concept of density is important to planning and design as it affects the vitality and viability of the place. The average density within the parish is quite low, at approximately 20 dwelling per hectare (dph), which is justified by its rural character.

The following guidelines highlight how new development should be designed to ensure that existing density within the parish is respected:

- Density should be appropriate to the location of any new development and its surroundings and enhance the character of the existing village;
- Housing densities should be reduced towards development edges and along rural edges in order to create a gradual

transition towards the countryside. The density in the developments bounded by West Avenues has low density of around 10dph. However, the density on Bramley Way is about 30dph (see the figures on this page);

- Pedestrian and cycle movement should be a priority and taken into account in larger development schemes. Housing density should support a 'human scale' development; and
- Small scale development and in-fills are encouraged, as they follow the scale and pattern of existing grain and streets and therefore, retain the character of the area.



**Figure 67:** Local example of a low density settlement on West Avenue with more gaps between properties and generous front and back gardens.



**Figure 68:** Example of higher density development on Bramley Way with reduced green spaces and gaps between properties.

## BF 05 DESIRED HEIGHT PROFILE

The following guidelines highlight the desired height profile of development:

- Development building heights should accord with the settlement character of two storey dwellings;
- Roofs in the village tend to be generally traditionally pitched, with some hipped examples. Some pitched dormers also can be seen in the area. The type and pitch of new roofs should reflect this;
- Innovation which explores the integration of green roof should be encouraged;
- The scale of the roof should always be in proportion to the dimensions of the building itself. Flat roofs for buildings, extensions, garages and dormer windows should be avoided; and
- Chimney type and height should be congruent with the typical Neighbourhood Plan Area chimney precedent examples.



**Figure 69:** Two-storey building and pitched roof built by slate and gabled dormer on Imperial Avenue.

**Figure 70:** Two-storey detached house with pitched roof built with brown pantile on Nipsells Chase.

**Figure 71:** Detached house with pitched roof built with gabled dormer on Mayland Quay.

## BF 06 ESTABLISH A CONSISTENT PROPERTY BOUNDARY

The following guidelines highlight the how to establish a consistent property boundary:

- Buildings should ordinarily front onto streets. The building line can have subtle variations in the form of recesses and protrusions, but will generally follow a consistent line;
- Buildings should be designed to ensure that streets and/or public spaces have good levels of natural surveillance from

adjacent buildings. This can be achieved by placing ground floor habitable rooms and upper floor windows facing the street;

- Natural boundary treatments should reinforce the sense of continuity of the building line and help define the street, appropriate to the character of the area. They should be mainly continuous hedges and low walls, as appropriate, made of traditional materials found elsewhere in the village;

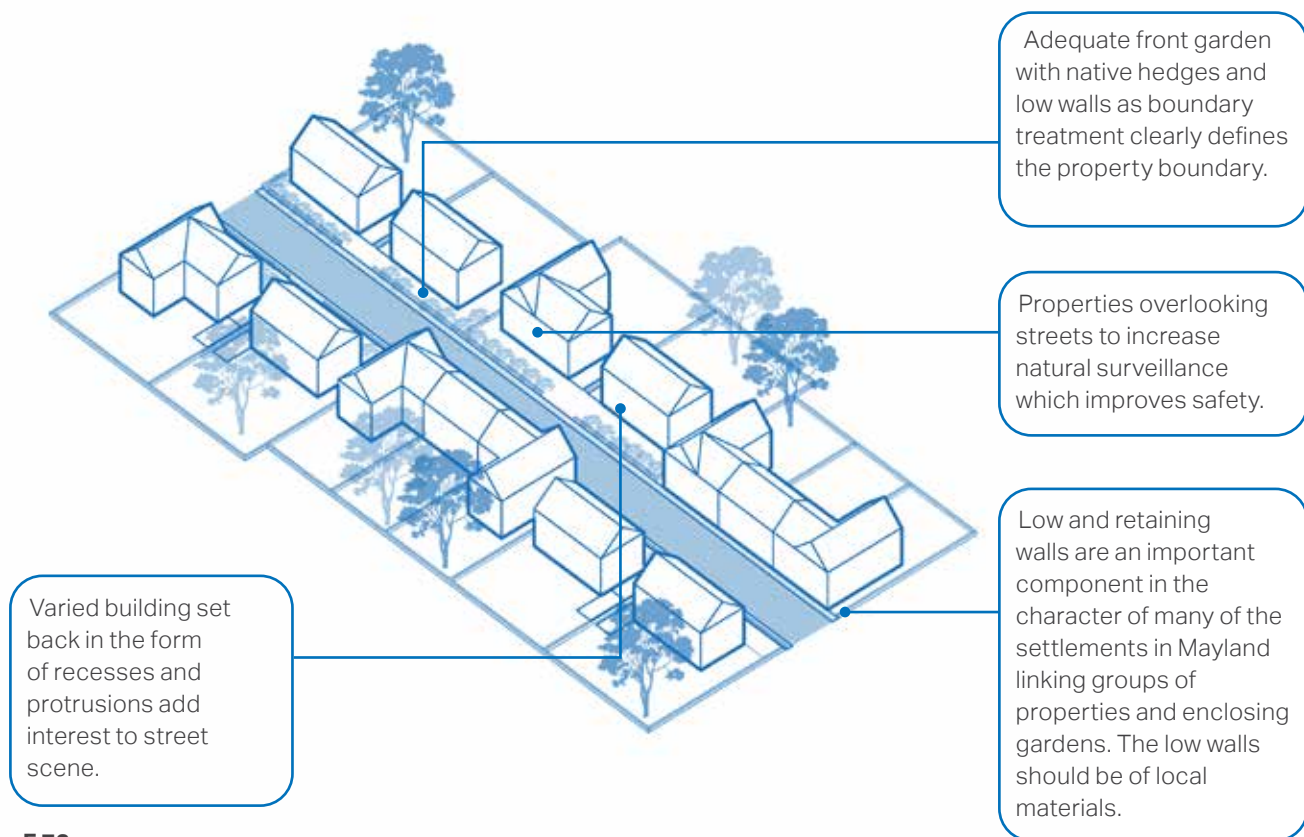

F.72

Figure 72: Illustrative diagram showing boundary treatments

- Front gardens/soft planted shallow setbacks should be provided in most instances, although it is recognised that there are some parts of Mayland where the prevailing character and form is one where buildings sit to the back of the footway/ highway;
- If placed on the property boundary, waste storage should be integrated as part of the overall design of the property. Landscaping could also be used to minimise the visual impact of bins and recycling containers; and
- Locally distinctive landscape features and planting, such as low wall boundary and hedges of native species should be used in new development to define boundaries. Any material that is not in keeping with the local character should be avoided.



F.73



F.74



F.75

**Figure 73:** A detached house with a low red brick wall and small trees on Imperial Avenue.

**Figure 74:** Grass verges to provide a degree of separation between the roadway and properties along West Avenue.

**Figure 75:** A two-storey house with hedge boundary treatment on Marine Parade.

## BF 07 EXTENSION AND CONVERSION

There are a number of principles that residential extensions and conversions should follow to maintain character:

- The original building should remain the dominant element of the property regardless of the scale or number of extensions. The newly built extension should not overwhelm the building from any given viewpoint;
- Extensions should not result in a significant loss to the private amenity area of the dwelling;
- Designs that wrap around the existing building and involve overly complicated roof forms should be avoided; and
- The form of the roof used on the building adds to its character and extensions should respond to this where appropriate.

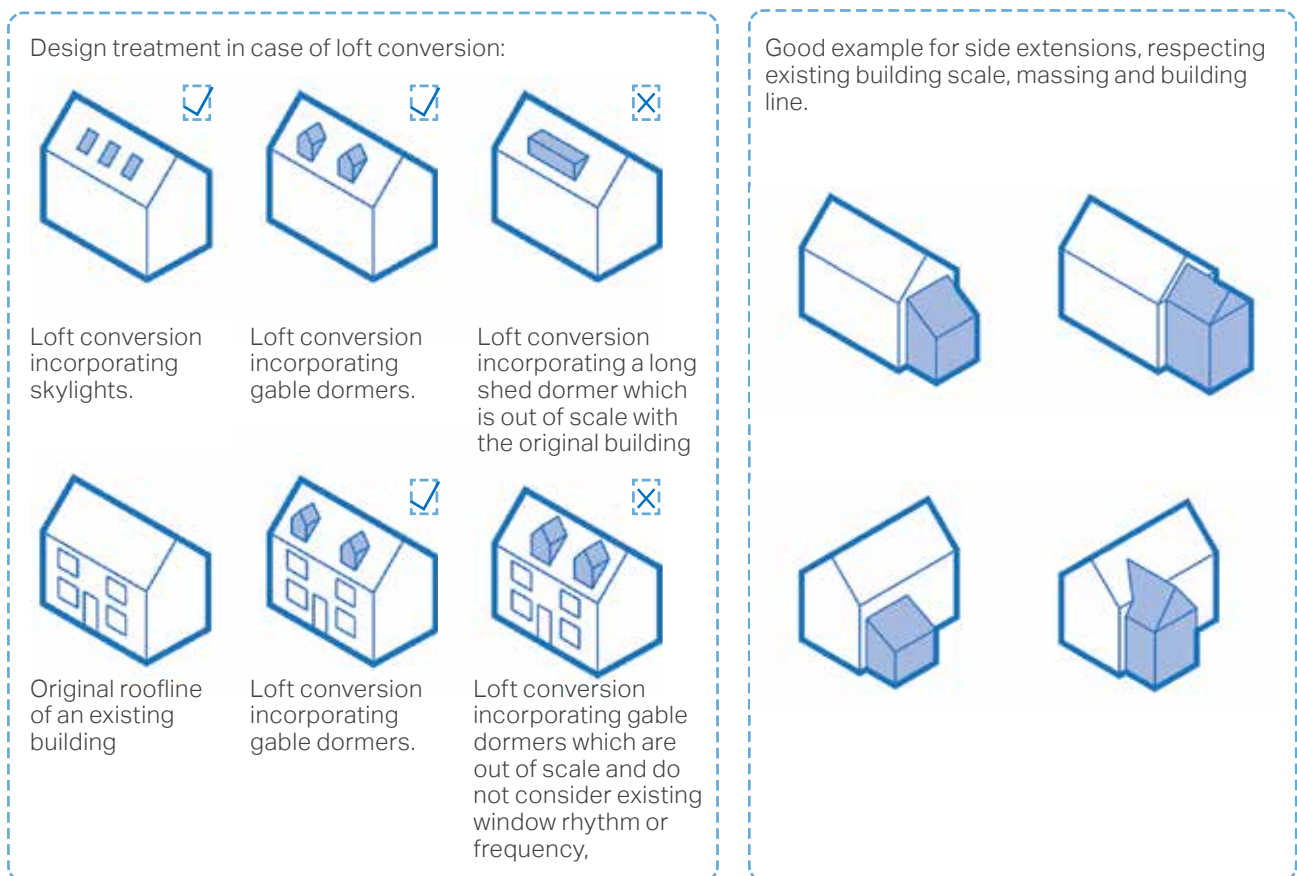

F.76

Figure 76: Some examples for different type of building extensions

- Extensions should consider the materials, architectural features, window sizes and proportions of the existing building and respect these elements to design an extension that matches and complements the existing building;
- In the case of side extensions, the new part of the building should be set back from the front of the main building and retain the proportions of the original building. This is in order to reduce any visual impact of the join between existing and new;
- In the case of rear extensions, the new part of the building should not have a harmful effect on neighbouring properties in terms of overshadowing, overlooking or privacy issues;
- Many household extensions are covered by permitted development rights, and so do not need planning permission. These rights do not apply in certain locations such as Conservation Areas;

- Any housing conversions should respect and preserve the original form and character of the building; and
- Where possible, reuse as much of the original materials as possible, or alternatively, use like-for-like materials. Any new materials should be sustainable and be used on less prominent parts of the building.



**Figure 77:** The original building should remain the dominate element of the property. The front extension is not of a sympathetic scale. The flat roof should be avoided in any future developments.



**Figure 78:** Positive example of side extension which complements the scale of the existing property, somewhere in the UK.



**Figure 79:** Detached property along School Road with well-proportioned dormer windows, somewhere in the UK.

## BF 08 ARCHITECTURAL DETAILS, MATERIALS AND COLOUR PALETTE

Mayland includes of properties with red brick facades, interspersed with off-white rendered facades. The rest of the settlement comprises isolated dwellings and scattered farmstead. There are three Grade II listed buildings within the parish such as the Mayland Mill Public House, Highlands Farmhouse and Barn.

Some of the buildings have modern extensions and alterations. New developments should encourage and support innovative and proactive approaches to design. Decentralised energy systems powered by a renewable or low carbon source and associated infrastructure are also encouraged and supported, including community-led initiatives.



F.81



F.82



F.80

**Figure 80:** Bungalow built with gault brick and pitched roof.

**Figure 81:** Two- storey family house built with timber yellow render and bay window.

**Figure 82:** Detached house with flat dormer, bay and casement windows.

New developments should strive for good quality design that meets climatic targets for CO2 emissions and that can be constructed sustainably, maximising opportunities for recycling.

Informed by the local vernacular, the following pages illustrate acceptable materials and detailing for future housing developments in Mayland. The use of traditional construction finishes should be specified for all new development and repair work. Material specification, quality for repair, replacement and modern developments should be maintained. The requirement for additional housing in the village should not trump Architectural quality and character of the area.

Future developments should carefully apply this code to avoid creating a pastiche of the existing local vernacular. Detailing can be interpreted using contemporary methods to avoid this.



F.83



F.84

**Figure 83:** Gabled house with protruded dormer windows. The building built with red brick and casement windows.  
**Figure 84:** Gambrel roof built with handmade red clay tile and roughcast render on The Mayland Mill Public House, a Grade II listed building. The property comprises a ranges of cottages.



**Figure 85:** A detached house built with red brick and render with timber frame, along with bay windows. Gabled roof constructed with red tile and chimney stacks.

**Figure 86:** A mixture of red and brown tiles hanging and buff brick on facade.

**Figure 87:** Two storey houses built with cladding and casement windows.

**Figure 88:** Housing surrounding a pond and built with red brick and red pantile.

The conversion of a historic building to a residential use should look to preserve and enhance existing heritage features and their setting to maintain the integrity of the original building. Any new fenestration should be carefully positioned to maintain the character and balance of the building and reflect the existing design through use of complementary materials and finishes. These conversions are an opportunity to provide a single large dwelling or a series of smaller dwellings.

### Wall materials

There are different wall materials in the village such as red brick, gault brick, render and timber.

### Types of fenestration

There are various materials used for windows and doors in Mayland such as sash, casement, vasistas, bay, bow windows and pithed porches.

### Roof materials and types

Of those roof materials in the village, red pantile, black glaze pantiles and slate are more prevalent.

The majority of buildings have pitched roofs, but hipped roofs can be found in the village too.

### Ground surface materials

Generally gravel and pebble cover the majority of the ground surface in the village. Concrete in herringbone pattern also used as surface material.

### Boundary treatment materials

There are a wide variety of boundary treatments in the village such as hedgerows, low walls with red brick and picket fencing.

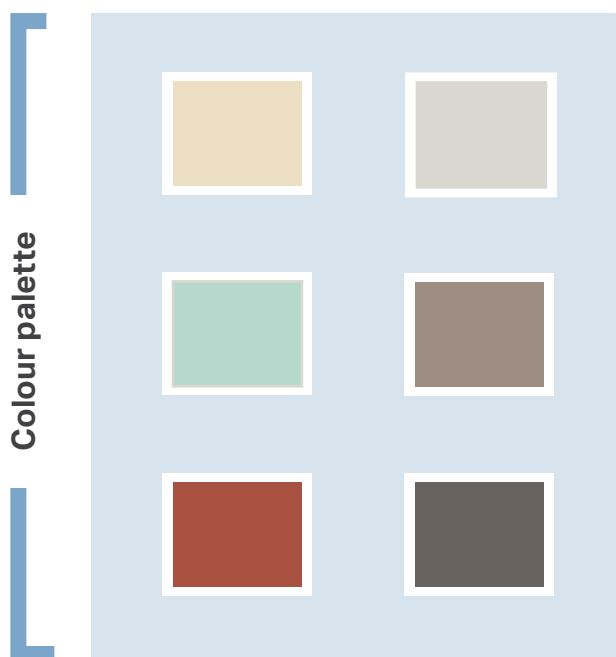

Wall materials



Red brick



Concrete hung tiles



White render



Mixture of render and timber



Gault brick



Mix of red brick and timber cladding

Types of fenestration



Vasistas window



Bay window



Bow windows



Sash window and lintel details



Casement window



Muntin detail



Wooden door



Door and decoration details

Roof materials and types



Slate



Bargeboard details



Gabled dormer



Black glaze pantile



Hipped roof built with slate



Red pantile and chimney stacks

Ground surface materials



Mix of gravel and paving



Gravel



Herringbone brick paving

Boundary treatment materials



Low wall built with gault brick



Low wall built with red brick



Hedge



Grass verge



Board fence



Well-kept front garden with shrub as a boundary treatment



Picket fencing



Hedges and shrubs

## BF 09 CORNER TREATMENT

An important villagescape principle is for buildings to satisfactorily address the corner. Where corner sites are visually prominent buildings should define the corner architecturally.

- Buildings should have two active frontages created by incorporating prominent entrances and windows;
- On corners which are less visually prominent, such as within the lower density residential areas, continuous built frontage should address the corner by using a series of linked dwellings where possible; and
- When a terraced, detached or semi-detached house faces out onto the corner, the buildings should have the main entrance and habitable room windows facing both sides to create activity and overlook the street. This building can also be taller or have a distinctive architectural element to ensure a greater presence.

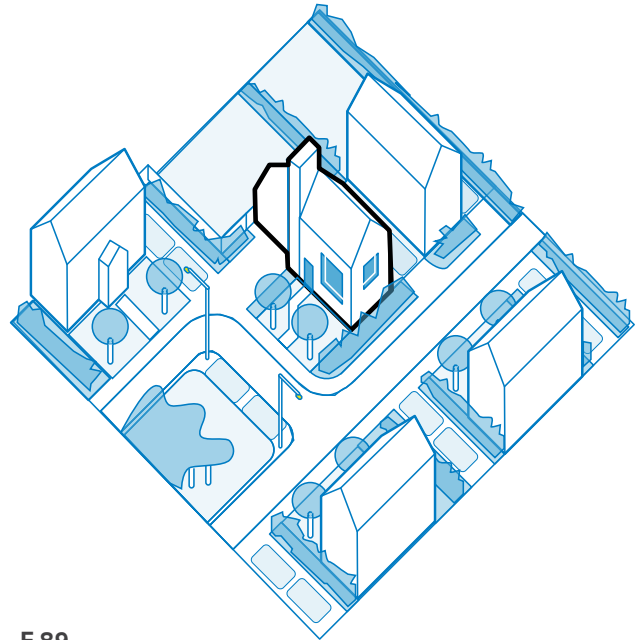

F.89

**Figure 89:** Diagram showing a corner building with two active frontages.

## EE. Environmental and energy efficiency

Design codes in the following section apply to the whole Neighbourhood Area. They contain important policies that will help to reduce our collective impact on the planet while allowing the natural environment in and around Mayland to flourish.

They include general guidance that apply to both new and existing development as some of the policies can be used to modify existing dwellings to become more environmentally sustainable.

Owing to Mayland's rich green space character, it is hoped that more of these policies are adopted in the future to help preserve and sustain this distinct character.

## EE 01 FEATURES IN DWELLINGS

The following section elaborates on energy efficient technologies that could be incorporated in buildings and at broader parish design scale as principles.

Use of such principles and design tools should be encouraged in order to contribute towards a more sustainable environment.

Energy efficient or eco design combines all around energy efficient appliances and lighting with commercially available renewable energy systems, such as solar electricity and/or solar/water heating and electric charging points.

New development is required to have regard to the Essex Design Guide - Climate Change guidance<sup>1</sup>.

<sup>1</sup> Available at <https://www.essexdesignguide.co.uk/climate-change/>



F.90

**Figure 90:** Diagram showing low-carbon homes in both existing and new build conditions.

### Existing homes

- 1  **Insulation**  
in lofts and walls (cavity and solid)
- 2  **Double or triple glazing with shading**  
(e.g. tinted window film, blinds, curtains and trees outside)
- 3  **Low-carbon heating**  
with heat pumps or connections to district heat network
- 4  **Draught proofing**  
of floors, windows and doors
- 5  **Highly energy-efficient appliances**  
(e.g. A++ and A+++ rating)
- 6  **Highly water-efficient devices**  
with low-flow showers and taps, insulated tanks and hot water thermostats
- 7  **Green space (e.g. gardens and trees)**  
to help reduce the risks and impacts of flooding and overheating
- 8  **Flood resilience and resistance**  
with removable air back covers, relocated appliances (e.g. installing washing machines upstairs), treated wooden floors

### Existing and new build homes

- A  **High levels of airtightness**
- B  **Triple glazed windows and external shading**  
especially on south and west faces
- C  **Low-carbon heating**  
and no new homes on the gas grid by 2025 at the latest
- D  **More fresh air**  
with mechanical ventilation and heat recovery, and passive cooling
- E  **Water management and cooling**  
more ambitious water efficiency standards, green roofs and reflective walls
- F  **Flood resilience and resistance**  
e.g. raised electrical, concrete floors and greening your garden
- G  **Construction and site planning**  
timber frames, sustainable transport options (such as cycling)
- H  **Solar panels**
- I  **Electric car charging point**

## EE 02 FLOOD MITIGATION

Flood risks which affects some parts of the parish as shown on Figure 19. It is important to note that no additional house building should take place on Flood Zone 3 area.

There are various ways to mitigate flood risk such as Sustainable urban Drainage Systems (SuDS), rainwater harvesting and permeable pavements, which are elaborated on the following pages.

New development is required to have regard to the SuDS Design Guide for Essex<sup>1</sup>.

## SUSTAINABLE DRAINAGE SYSTEMS

The term SuDS refers to a range of approaches to managing surface water in a more sustainable way to reduce flood risk and improve water quality whilst improving amenity benefits.

SuDS work by reducing the amount and rate at which surface water reaches a waterway or combined sewer system. Usually, the most sustainable option is collecting this water for reuse, for example in a water butt or rainwater harvesting system, as this has the added benefit of reducing pressure on important water sources.

Where reuse is not possible there are two alternative approaches using SuDS:

- Infiltration, which allows water to percolate into the ground and eventually restore groundwater; and

- Attenuation and controlled release, which holds back the water and slowly releases it into the sewer network. Although the overall volume entering the sewer system is the same, the peak flow is reduced. This reduces the risk of sewers overflowing. Attenuation and controlled release options are suitable when either infiltration is not possible (for example where the water table is high or soils are clay) or where infiltration could be polluting (such as on contaminated sites).

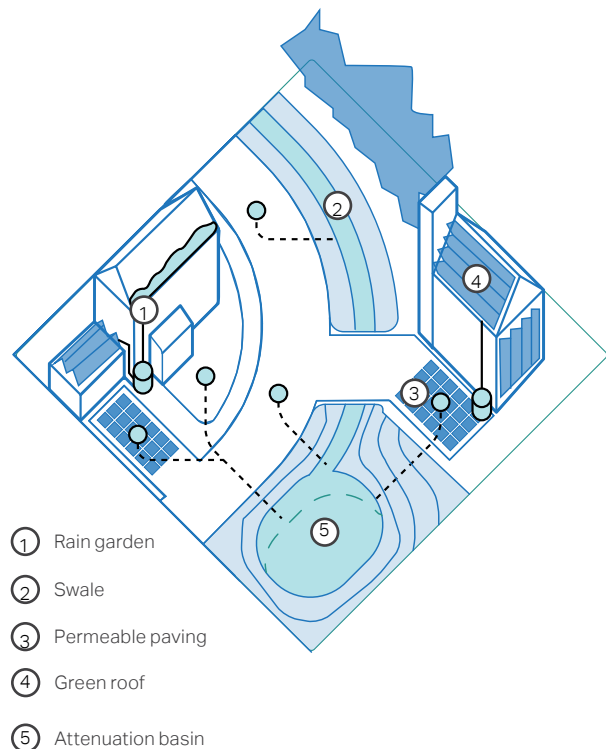

F.91

Figure 91: Diagram showing the best use of harvesting water systems rain garden, swales, permeable paving, green roofs

1 Available at <https://www.essexdesignguide.co.uk/suds>

The most effective type or design of SuDS would depend on site-specific conditions such as underlying ground conditions, infiltration rate, slope, or presence of ground contamination. A number of overarching principles can however be applied:

- Reduce runoff rates by facilitating infiltration into the ground or by providing attenuation that stores water to help slow its flow down so that it does not overwhelm water courses or the sewer network;
- Integrate into development and improve amenity through early consideration in the development process and good design practices;
- SuDS are often as important in areas that are not directly in an area of flood risk themselves, as they can help reduce downstream flood risk by storing water upstream;
- Some of the most effective SuDS are vegetated, using natural processes to slow and clean the water whilst increasing the biodiversity value of the area;
- Best practice SuDS schemes link the water cycle to make the most efficient use of water resources by reusing surface water; and
- SuDS must be designed sensitively to augment the landscape and provide biodiversity and amenity benefits.



F.92

**Figure 92:** Examples of SuDS designed as a public amenity and fully integrated into the design of the public realm, Sweden.

## RAINWATER HARVESTING

Rainwater harvesting is a system for capturing and storing rainwater as well as enabling the reuse of in-situ grey water. Some design considerations include:

- Concealing tanks with complementary cladding;
- Use attractive materials or finishing for pipes, unsightly pipes should be avoided;
- Combine landscape or planters with water capture systems; and
- Use underground tanks.



**Figure 93:** Example of a rainwater harvesting tank in the shape of a beehive.

**Figure 94:** Example of a modular water tank.

## PERMEABLE PAVEMENTS

Most built-up areas, including roads and driveways, increase impervious surfaces and reduce the capacity of the ground to absorb runoff water. This in turn increases the risks of surface water flooding. Permeable pavements offer a solution to maintain soil permeability while performing the function of conventional paving. The choice of permeable paving units must be made depending on the local context; the units may take the form of unbound gravel, clay pavers, or stone setts.

Permeable paving can be used where appropriate on footways, public squares, private access roads, driveways, and private areas within the individual development boundaries.

It is recommended that the majority of the unbuilt areas in the plot (i.e. gardens) are permeable by means of landscape such as grass or earth as well as permeable and

filtrating pavements. As a rule of thumb the % of permeable area should be between 30% to 70% of the unbuilt areas.

In addition, permeable pavement must also comply with:

- Flood and Water Management Act 2010, Schedule 3;<sup>1</sup>
- The Building Regulations Part H – Drainage and Waste Disposal;<sup>2</sup> and
- Town and Country Planning (General Permitted Development) (England) Order 2015.<sup>3</sup>

<sup>1</sup> Great Britain (2010). *Flood and Water Management Act, Schedule 3*. Available at: <http://www.legislation.gov.uk/ukpga/2010/29/schedule/3>

<sup>2</sup> Great Britain (2010). *The Building Regulations Part H – Drainage and Waste Disposal*. Available at: [https://assets.publishing.service.gov.uk/government/uploads/system/uploads/attachment\\_data/file/442889/BR\\_PDF\\_AD\\_H\\_2015.pdf](https://assets.publishing.service.gov.uk/government/uploads/system/uploads/attachment_data/file/442889/BR_PDF_AD_H_2015.pdf)

<sup>3</sup> Great Britain (2015). *Town and Country Planning (General Permitted Development) (England) Order 2015*. Available at: [http://www.legislation.gov.uk/uksi/2015/596/pdfs/ukxi\\_20150596\\_en.pdf](http://www.legislation.gov.uk/uksi/2015/596/pdfs/ukxi_20150596_en.pdf)

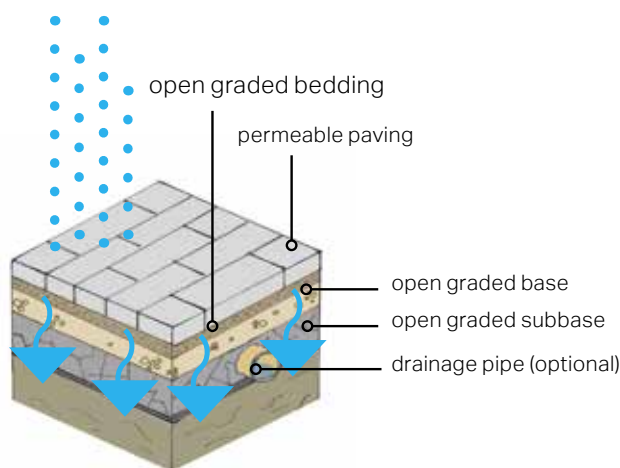
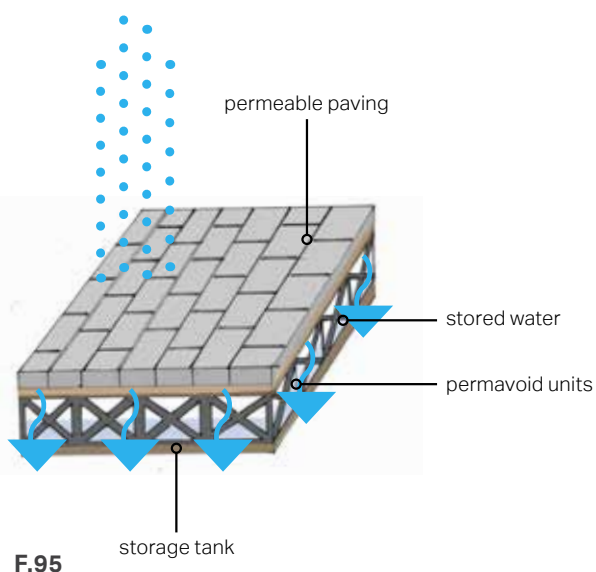

Figure 95: Diagrams illustrating the functioning of a soak away

Regulations, standards, and guidelines relevant to permeable paving and sustainable drainage are listed below:

- Sustainable Drainage Systems - non-statutory technical standards for sustainable drainage systems;<sup>1</sup>
- The SuDS Manual (C753);<sup>2</sup>
- BS 8582:2013 Code of practice for surface water management for development sites;<sup>3</sup>
- BS 7533-13:2009 Pavements constructed with clay, natural stone or concrete pavers;<sup>4</sup> and
- Guidance on the Permeable Surfacing of Front Gardens.<sup>5</sup>

<sup>1</sup> Great Britain. Department for Environment, Food and Rural Affairs (2015). *Sustainable drainage systems – non-statutory technical standards for sustainable drainage systems*. Available at: [https://assets.publishing.service.gov.uk/government/uploads/system/uploads/attachment\\_data/file/415773/sustainable-drainage-technical-standards.pdf](https://assets.publishing.service.gov.uk/government/uploads/system/uploads/attachment_data/file/415773/sustainable-drainage-technical-standards.pdf)

<sup>2</sup> CIRIA (2015). *The SuDS Manual (C753)*.

<sup>3</sup> British Standards Institution (2013). *BS 8582:2013 Code of practice for surface water management for development sites*. Available at: <https://shop.bsigroup.com/ProductDetail/?pid=000000000030253266>

<sup>4</sup> British Standards Institution (2009). *BS 7533-13:2009 Pavements constructed with clay, natural stone or concrete pavers*. Available at: <https://shop.bsigroup.com/ProductDetail/?pid=000000000030159352>

<sup>5</sup> Great Britain. Ministry of Housing, Communities & Local Government (2008). *Guidance on the Permeable Surfacing of Front Gardens*. Available at: [https://assets.publishing.service.gov.uk/government/uploads/system/uploads/attachment\\_data/file/7728/pavingfrontgardens.pdf](https://assets.publishing.service.gov.uk/government/uploads/system/uploads/attachment_data/file/7728/pavingfrontgardens.pdf)

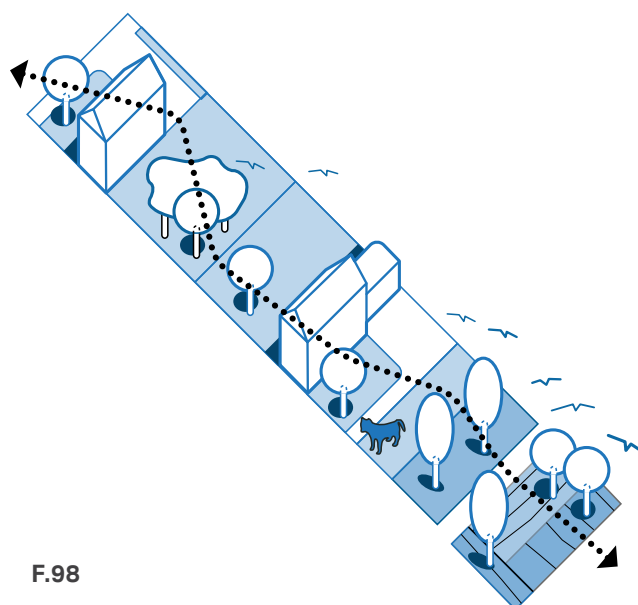

**Figure 96:** A good example of permeable paver (Source: <https://www.paverconnection.com/testimonial/hedwig-village-permeable-driveway-and-patio-upgrade/>).  
**Figure 97:** A good example of clay paver (Source: <https://www.londonstone.co.uk/brick-pavers/paving-bricks/>)

### EE 03- WILDLIFE FRIENDLY FEATURES

Biodiversity and woodlands should be protected and enhanced where possible. All development is required by law to deliver a minimum of 10% biodiversity net gain.

- Roadside verges, hedges, and trees should act as natural buffers and should be protected when planning new developments;
- Abrupt edges to development with little vegetation or landscape on the edge of the settlement should be avoided and, instead, comprehensive landscape buffering should be encouraged;
- New developments and building extensions should aim to strengthen biodiversity and the natural environment;
- Ensure habitats are buffered. Widths of buffer zones should be wide enough and based on specific ecological function;



F.98



F.99



F.100

**Figure 98:** Diagram to highlight the importance of creating wildlife corridors.  
**Figure 99:** Examples of a bughouse decorating rear gardens or public green spaces.  
**Figure 100:** Examples of a frog habitat decorating rear gardens or public green spaces.

- New development proposals should include the creation of new habitats and wildlife corridors. This could be by aligning back and front gardens or installing bird boxes or bricks in walls and improve habitat at ponds. Wildlife corridors should be included to enable local wildlife to travel to and from foraging areas and their dwelling area;
- Reinstatement of the line of trees to the east side of The Drive which previously was as a place with huge elms trees;
- Avoid low maintenance gardens which are harmful to wildlife by reducing hard landscaping; and
- The loss of any tree and garden should be discouraged. Encourage permeable pavement and garden. In addition, better upkeep of grass verges, hedges and dykes and ditches within the village can be beneficial to biodiversity net gain.



F.101

Figure 101: View towards Lawling Creek and Blackwater Marina.

## 4.2 Checklist

As the design guidance and codes in this document cannot cover all design eventualities, this chapter provides a number of questions based on established good practice against which the design proposal should be evaluated. The aim is to assess all proposals by objectively answering the questions below. Not all the questions will apply to every development. The relevant ones, however, should provide an assessment as to whether the design proposal has considered the context and provided an adequate design solution.

As a first step there are a number of ideas or principles that should be present in all proposals. These are listed under 'General design guidance for new development'. Following these ideas and principles, questions are listed for more specific topics on the following pages.

# 1

## General design guidelines for new development:

- New development will integrate with existing paths, streets, circulation networks and patterns of activity;
- Reinforce or enhance the established settlement character of streets, greens, and other spaces;
- Harmonise with and enhance the existing settlement in terms of physical form, architecture and land use;
- Relate well to local topography and landscape features, including prominent vegetation and long-distance views;
- Reflect, respect, and reinforce local architecture and historic distinctiveness;
- Retain and incorporate important existing features into the development;
- Respect surrounding buildings in terms of scale, height, form and massing;
- Adopt contextually appropriate materials and details;
- Provide adequate open space for the development in terms of both quantity and quality;
- Incorporate necessary services and drainage infrastructure without causing unacceptable harm to retained features;
- Ensure all components e.g. buildings, landscapes, access routes, parking and open space are well related to each other;
- Make sufficient provision for sustainable waste management (including facilities for kerbside collection, waste separation, and minimisation where appropriate) without adverse impact on the street scene, the local landscape or the amenities of neighbours;
- Positively integrate energy efficient technologies;
- Ensure that places are designed with management, maintenance and the upkeep of utilities in mind; and
- Seek to implement passive environmental design principles by, firstly, considering how the site layout can optimise beneficial solar gain and reduce energy demands (e.g. insulation), before specification of energy efficient building services and finally incorporate renewable energy sources.

## 2

### Street grid and layout:

- Does it favour accessibility and connectivity? If not, why?
- Do the new points of access and street layout have regard for all users of the development; in particular pedestrians, cyclists and those with disabilities?
- What are the essential characteristics of the existing street pattern; are these reflected in the proposal?
- How will the new design or extension integrate with the existing street arrangement?
- Are the new points of access appropriate in terms of patterns of movement?
- Do the points of access conform to the statutory technical requirements?

## 3

### Local green spaces, views & character:

- What are the particular characteristics of this area which have been taken into account in the design; i.e. what are the landscape qualities of the area?
- Does the proposal maintain or enhance any identified views or views in general?
- How does the proposal affect the trees on or adjacent to the site?
- Can trees be used to provide natural shading from unwanted solar gain? i.e. deciduous trees can limit solar gains in summer, while maximising them in winter.
- Has the proposal been considered within its wider physical context?

## 3

### Local green spaces, views & character:

- Has the impact on the landscape quality of the area been taken into account?
- In rural locations, has the impact of the development on the tranquillity of the area been fully considered?
- How does the proposal impact on existing views which are important to the area and how are these views incorporated in the design?
- Can any new views be created?
- Is there adequate amenity space for the development?
- Does the new development respect and enhance existing amenity space?
- Have opportunities for enhancing existing amenity spaces been explored?
- Will any communal amenity space be created? If so, how this will be used by the new owners and how will it be managed?
- Is there opportunity to increase the local area biodiversity?
- Can green space be used for natural flood prevention e.g. permeable landscaping, swales etc.?
- Can water bodies be used to provide evaporative cooling?
- Is there space to consider a ground source heat pump array, either horizontal ground loop or borehole (if excavation is required)?

# 4

## Gateway and access features:

- What is the arrival point, how is it designed?
- Does the proposal maintain or enhance the existing gaps between settlements?
- Does the proposal affect or change the setting of a listed building or listed landscape?
- Is the landscaping to be hard or soft?

# 5

## Buildings layout and grouping:

- What are the typical groupings of buildings?
- How have the existing groupings been reflected in the proposal?
- Are proposed groups of buildings offering variety and texture to the townscape?
- What effect would the proposal have on the streetscape?
- Does the proposal maintain the character of dwelling clusters stemming from the main road?
- Does the proposal overlook any adjacent properties or gardens? How is this mitigated?
- Subject to topography and the clustering of existing buildings, are new buildings oriented to incorporate passive solar design principles, with, for example, one of the main glazed elevations within 30° due south, whilst also minimising overheating risk?
- Can buildings with complementary energy profiles be clustered together such that a communal low carbon energy source could be used to supply multiple buildings that might require energy at different times of day or night? This is to reduce peak loads. And/or can waste heat from one building be extracted to provide cooling to that building as well as heat to another building?

# 6

## Building line and boundary treatment:

- What are the characteristics of the building line?
- How has the building line been respected in the proposals?
- Has the appropriateness of the boundary treatments been considered in the context of the site?

# 7

## Building heights and roofline:

- What are the characteristics of the roofline?
- Have the proposals paid careful attention to height, form, massing and scale?
- If a higher than average building(s) is proposed, what would be the reason for making the development higher?
- Will the roof structure be capable of supporting a photovoltaic or solar thermal array either now, or in the future?
- Will the inclusion of roof mounted renewable technologies be an issue from a visual or planning perspective? If so, can they be screened from view, being careful not to cause over shading?

# 8

## Household extensions:

- Does the proposed design respect the character of the area and the immediate neighbourhood?
- What is the impact of the proposed changes/extension on the surrounding environment, including green space and parking/pedestrian access?
- Is the roof form of the extension appropriate to the original dwelling?
- Do the proposed materials match those of the existing dwelling?
- In case of side extensions, does it retain important gaps within the street scene and avoid a 'terracing effect'?
- Are there any proposed dormer roof extensions set within the roof slope?
- Does the proposed extension respond to the existing pattern of window and door openings?
- Is the side extension set back from the front of the house?
- Does the extension offer the opportunity to retrofit energy efficiency measures to the existing building?
- Can any materials be re-used in situ to reduce waste and embodied carbon?
- What is the impact of the proposed changes/extension on the surrounding environment, including green space and parking/pedestrian access?

# 9

## Building materials & surface treatment:

- What is the distinctive material in the area?
- Does the proposed material harmonise with the local materials?
- Does the proposal use high-quality materials?
- Have the details of the windows, doors, eaves and roof details been addressed in the context of the overall design?
- Does the new proposed materials respect or enhance the existing area or adversely change its character?
- Are recycled materials, or those with high recycled content proposed?
- Has the embodied carbon of the materials been considered and are there options which can reduce the embodied carbon of the design? For example, wood structures and concrete alternatives.
- Can the proposed materials be locally and/or responsibly sourced? E.g. FSC timber, or certified under BES 6001, ISO 14001 Environmental Management Systems?

# 10

## Car parking:

- What parking solutions have been considered?
- Are the car spaces located and arranged in a way that is not dominant or detrimental to the sense of place?
- Has planting been considered to soften the presence of cars?
- Does the proposed car parking compromise the amenity of adjoining properties?
- Have the needs of wheelchair users been considered?
- Can electric vehicle charging points be provided?
- Can secure cycle storage be provided at an individual building level or through a central/ communal facility where appropriate?
- If covered car ports or cycle storage is included, can it incorporate roof mounted photovoltaic panels or a biodiverse roof in its design?
- Has adequate off road parking been provided for each dwelling?
- Does the proposed parking arrangement provide sufficient security and deter anti-social behaviour/crime?

# 11

## Architectural details and design:

- If the proposal is within a conservation area, how are the characteristics reflected in the design?
- Does the proposal harmonise with the adjacent properties? This means that it follows the height massing and general proportions of adjacent buildings and how it takes cues from materials and other physical characteristics.
- Does the proposal maintain or enhance the existing landscape features?
- Has the local Architectural character and precedent been demonstrated in the proposals?
- If the proposal is a contemporary design, are the details and materials of a sufficiently high enough quality and does it relate specifically to the Architectural characteristics and scale of the site?
- Is it possible to incorporate passive environmental design features such as larger roof overhangs, deeper window reveals and/or external louvres/shutters to provide shading in hotter months?
- Can the building designs utilise thermal mass to minimise heat transfer and provide free cooling?
- Can any external structures such as balconies be fixed to the outside of the building, as opposed to cantilevering through the building fabric to reduce thermal bridge?

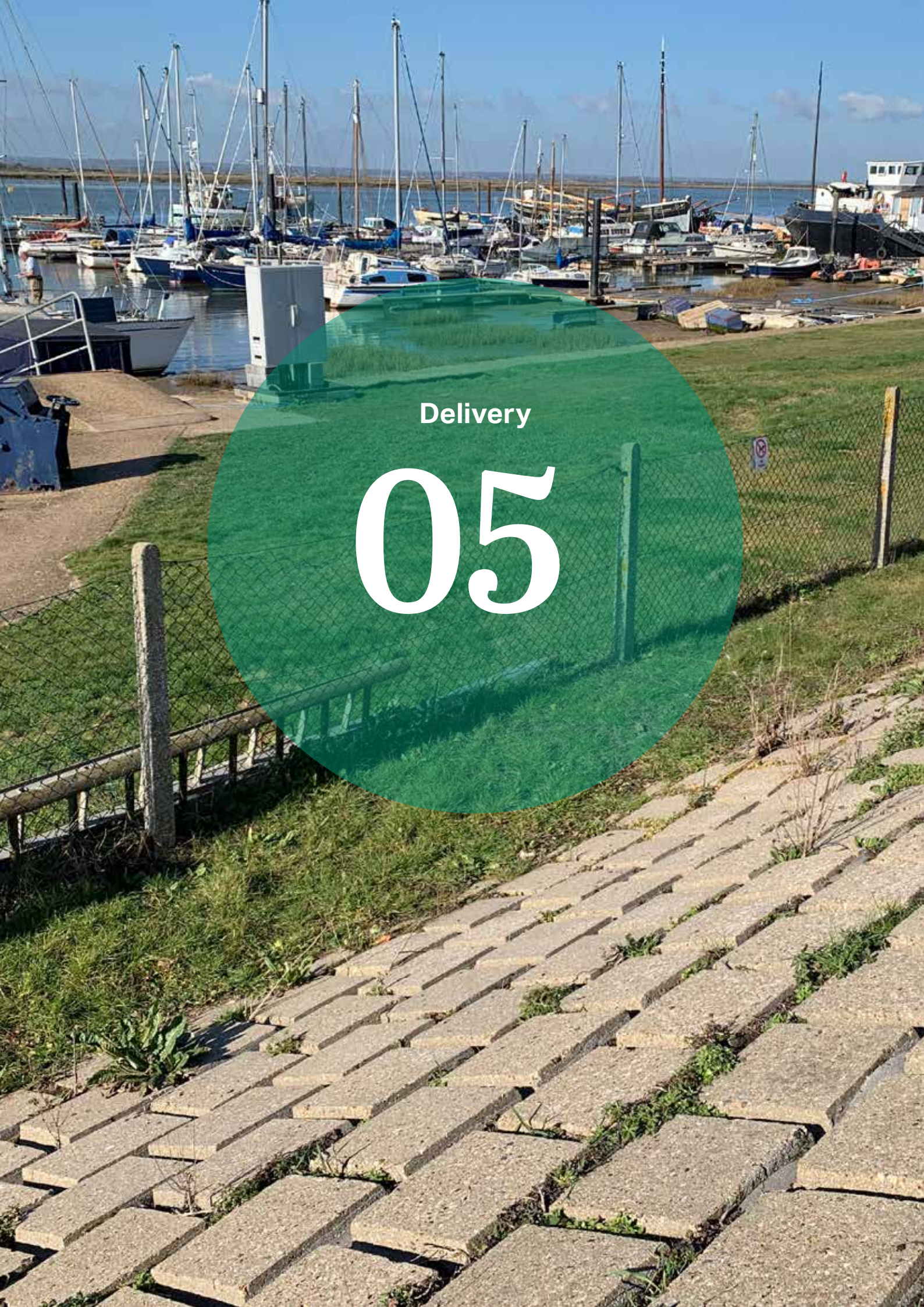

Delivery

05

## 5. Delivery

The design guidelines and codes will be a valuable tool in securing context-driven, high quality development in Mayland. They will be used in different ways by different actors in the planning and development process, as summarised in the table.

Actors	How they will use the design guidelines
<b>Applicants, developers, &amp; landowners</b>	As a guide to community and Local Planning Authority expectations on design, allowing a degree of certainty – they will be expected to follow the Guidelines as planning consent is sought.
<b>Local Planning Authority</b>	As a reference point, embedded in policy, against which to assess planning applications.  The Design Guidelines should be discussed with applicants during any pre-application discussions.
<b>Parish Council</b>	As a guide when commenting on planning applications, ensuring that the Design Guidelines are complied with.
<b>Community organisations</b>	As a tool to promote community-backed development and to inform comments on planning applications.
<b>Statutory consultees and Essex County Council</b>	As a reference point when commenting on planning applications.

## About AECOM

AECOM is the world's trusted infrastructure consulting firm, delivering professional services throughout the project lifecycle — from planning, design and engineering to program and construction management. On projects spanning transportation, buildings, water, new energy and the environment, our public- and private-sector clients trust us to solve their most complex challenges. Our teams are driven by a common purpose to deliver a better world through our unrivaled technical expertise and innovation, a culture of equity, diversity and inclusion, and a commitment to environmental, social and governance priorities. AECOM is a *Fortune 500* firm and its Professional Services business had revenue of \$13.2 billion in fiscal year 2020. See how we are delivering sustainable legacies for generations to come at [aecom.com](http://aecom.com) and [@AECOM](https://www.instagram.com/AECOM).